



PROFESSIONAL  
**WORK**



**KITS**  
KIT p. 6\_25

1

**HELMETS**  
CASCHI p. 26\_33

2

**HARNESSES**  
IMBRACATURE p. 34\_42

3

**GLOVES**  
GUANTI p. 43\_45

4

**FALL ARRESTERS & POSITIONING**  
ANTICADUTA E POSIZIONAMENTO p. 46\_55

5

**ANCHORING TOOLS**  
ANCORAGGI p. 56\_65

6

**LIFTING DEVICES**  
DISPOSITIVI DI SOLLEVAMENTO p. 66\_69

7

**CONNECTORS**  
CONNETTORI p. 70\_85

8

**DESCENDERS**  
DISCENSORI p. 86\_91

9

**ROPE CLAMPS**  
BLOCCANTI p. 92\_97

10

**PULLEYS**  
CARRUCOLE p. 98\_104

11

**ROPES & ACCESSORIES**  
CORDE E ACCESSORI p. 105\_109

12

**BAGS**  
SACCHI p. 110\_115

13

**CODE INDEX**  
INDICE DEI CODICI p. 118\_120

14

## MADE IN ITALY SINCE 1830

The origin of Kong starts from afar, around 1830 in a workshop at the foot of the Alps, where Giuseppe Bonaiti gave rise to our story, writing important pages for Made in Italy. The care for maximum protection of human lives, together with the dreams that men “hang” climbing the peaks, led Bonaiti to export his products and philosophy all over the world.

His carabiners have become real fixed points for everyone who practices vertical disciplines.

In 1977 Bonaiti company changed its name to Kong, but the mission remains the same:

### “Being a manufacturer of safety where the risk is the protagonist”

The entire production cycle, from the design to the packaging is made in our factory of 10,000 square meters located in Monte Marengo (LC), Italy, where each PPE (Personal Protective Equipment) is tested piece by piece and then sold all over the world.

We can proudly say that, first of all, we are “manufacturers”:

- our 70 employees perform their daily activities with passion to produce high quality systems that ensure maximum safety
- our robots test 100% of our items at 70% of the breaking load
- our operators check 100% of the appearance and functionality of our products

### “KONG, from the past to the future, the evolution of safety”

## MADE IN ITALY DAL 1830

Le origini di Kong partono da lontano, esattamente nel 1830 in un'officina meccanica situata ai piedi delle Alpi, dove Giuseppe Bonaiti ha dato inizio alla nostra storia, scrivendo pagine importanti del Made in Italy.

L'attenzione per la massima protezione delle vite umane, insieme ai sogni che questi uomini “appendono” scalando le vette, ha portato Bonaiti ad esportare in tutto il mondo la sua filosofia e i suoi prodotti.

I suoi “moschettoni” sono diventati concretamente punti fissi per chiunque pratichi discipline verticali.

Nel 1977 l'azienda Bonaiti cambia nome in Kong, ma l'impronta rimane sempre la stessa:

### “Essere produttori di sicurezza dove il rischio è protagonista”

L'intero ciclo di produzione, dalla progettazione al confezionamento, avviene all'interno dei 10.000 mq dello stabilimento di Monte Marengo (LC) Italia, dove ogni DPI (Dispositivo di Protezione Individuale) viene testato pezzo per pezzo e venduto in tutto il mondo.

Con orgoglio possiamo dire di essere innanzitutto produttori:

- i nostri 70 dipendenti svolgono le loro attività quotidiane con passione, per produrre sistemi di alta qualità che garantiscono la massima sicurezza
- i nostri robots testano il 100% dei connettori trazionandoli a circa il 70% del carico marcato
- i nostri operatori controllano il 100% dei prodotti valutandone la perfetta funzionalità e l'aspetto estetico

### “KONG, dal passato al futuro, l'evoluzione della sicurezza”

Kong headquarters with private airfield N 45° 45' 43" E 9° 26' 47", Monte Marengo (Lecco) - ph: Kong

Watch the video  
Guarda il video



### QUALITY CONTROL AND CERTIFICATIONS

KONG, since the beginning, has always followed strict rules to ensure that each product withstands expected loads, controlling and testing piece by piece. This means that when we design a new item, we build a prototype and have it tested by a notified body that verifies compliance with the standards. Then we put it into production with the absolute guarantee that the millionth piece is identical to the first piece produced. This also applies to the production of carry over products.

As a further guarantee to the end user, most of the KONG products are certified according to UIAA - International Climbing and Mountaineering Federation standards and to CE norms.

Many of our items are also certified according to special standards: NFPA - ANSI - RINA - ASTM - EASA or to military specifications.

Kong also followed its natural evolution towards a quality management system and has been certified for more than 20 years, today according to ISO 9001, which is applied to all our business processes.

### CONTROLLO DI QUALITÀ E CERTIFICAZIONI

La KONG, fin dalle origini, si è sempre data delle regole ferree per garantire che ogni prodotto resistesse ai carichi previsti, controllandolo e testandolo pezzo per pezzo. Questo vuol dire che quando si progetta un nuovo articolo, si costruisce un prototipo, lo si fa testare da un organismo notificato che ne verifica la conformità agli standard e poi lo si mette in produzione con la garanzia assoluta che il milionesimo pezzo sia identico in tutto e per tutto al primo pezzo prodotto. Questo vale anche per la produzione di articoli consolidati.

Ad ulteriore garanzia dell'utilizzatore finale, la maggior parte dei prodotti KONG è certificata secondo gli standard UIAA (Unione Internazionale delle Associazioni Alpinistiche) e le norme CE.

Molti nostri articoli sono inoltre certificati in accordo alle norme NFPA - ANSI - RINA - ASTM - EASA o a specifiche militari.

L'organizzazione della KONG ha poi trovato la sua naturale evoluzione nel sistema di gestione per la qualità certificato da oltre vent'anni, secondo la norma UNI EN ISO 9001 applicata a tutti i processi aziendali.



Kong SpA is organized with a quality management system certified UNI EN ISO 9001 for the planning and delivery of training services for professional purposes, paying particular attention to safety in the workplace. The standard courses are in catalog or customized according to specific needs, always complying with current legislation. Training activities are held in our indoor structure, equipped to carry out theoretical and practical sessions, or, if requested, at the customer's premises. Kong teachers are qualified and experienced with the skills required by current legislation. Kong also has a reminding system that allows clients to be notified about necessary updating training.

Up to now, more than 3000 hours of training were provided to Special Forces and Police, to emergency rescue technician (Fire Brigade, Civil Defence, etc..) and to ordinary and extraordinary healthcare rescue teams (118, Red Cross and various service associations), as well to operators of adventure parks, professionals and employees of private companies.

Registered to regional register of the entities accredited for services of education and professional training n. 845.

IRATA training company n° 5058/T. SPRAT sustaining member.

Kong SpA è organizzata con un sistema di gestione per la qualità certificato UNI EN ISO 9001 per la progettazione ed erogazione di servizi di formazione nell'ambito del sistema di istruzione e formazione professionale, con particolare riferimento alla sicurezza sui luoghi di lavoro. I corsi sono a catalogo o personalizzati secondo esigenze specifiche, pur nel rispetto della normativa vigente.

Le attività di formazione si svolgono presso la nostra struttura coperta, attrezzata per lo svolgimento di attività didattica teorica e pratica, o, se richiesto, presso la sede del cliente. I docenti Kong sono qualificati e con esperienza oltre a possedere le competenze richieste dalla normativa vigente. Kong SpA dispone inoltre di un sistema di reminding che permette ai clienti di essere avvisati per tempo circa gli aggiornamenti formativi necessari, quando previsto.

Ad oggi sono oltre 3000 le ore di formazione erogate che hanno riguardato personale delle Forze armate e delle Forze dell'ordine, del Soccorso tecnico urgente (VFFF, Protezione Civile, ecc.) e del Soccorso sanitario ordinario e straordinario (118, Croce Rossa e Opere varie di Assistenza) nonché operatori di parchi acrobatici, liberi professionisti e lavoratori di imprese private.

Soggetto Formatore Accreditato Regione Lombardia n. 845.

Società di formazione IRATA n° 5058/T. Sostenitore SPRAT.



### Here you find the list of offered courses:

- Training course for PPE and Kong complex equipment inspection (8 hours).
- Training course for Rope Access Worker, Module base + A, specific practice for industrial, offshore and onshore sites (32 hours).
- Refresher course for Rope Access Worker module A (8 hours)
- Training course for supervisor of Rope Access Safety (8 hours).
- Five-year refresher course for supervisor (8 hours).
- Training course on the correct use of Category III PPE for work on height (8 hours).
- Rope access course for sail boat owners (16 hours).
- Rope Courses/Adventure Park instructor course (24 hours)
- Rope Courses/Adventure Park rescuer course (8 hours)
- Confined spaces training course (16 hours).
- Five-year confined spaces refresher course (4 hours).
- Training course for the correct use of portable ladders (4 hours).
- Training course on the correct use of scaffolding and trestles (4 hours)
- Access by ropes to Heritage Buildings (40 hours)
- Training course for COUDOU PRO installers (8 hours)
- Training course in rope access and work positioning IRATA Lev.1 (40 hours)
- Training course in rope access and work positioning IRATA Lev.2 (40 hours)
- Training course in rope access and work positioning IRATA Lev.3 (40 hours)

### Qui di seguito l'elenco dei corsi proposti:

- Corso di formazione per l'ispezione DPI e attrezzature complesse Kong (8 ore).
- Corso di formazione per addetti a sistemi di accesso e posizionamento mediante funi, modulo base+ A specifico pratico per l'accesso ed il lavoro in sospensione in siti naturali o artificiali (32 ore).
- Corso di aggiornamento per addetti a sistemi di accesso e posizionamento mediante funi mod.A (8 ore).
- Corso di formazione per preposti alla sorveglianza dei sistemi di accesso e posizionamento mediante funi (8 ore).
- Corso di aggiornamento quinquennale per preposti alla sorveglianza dei sistemi di accesso e posizionamento mediante funi (8 ore).
- Corso di formazione ed addestramento al corretto uso dei DPI di 3a categoria per lavori in quota (8 ore).
- Corso funi per armatori barche a vela (16 ore).
- Corso istruttore parchi acrobatici (24 ore) conforme al protocollo stabilito dall'associazione parchi avventura italiani.
- Corso soccorritore parchi acrobatici (8 ore) conforme al protocollo stabilito dall'associazione parchi avventura italiani.
- Corso di formazione ambienti confinati (16 ore).
- Corso aggiornamento ambienti confinati quinquennale (4 ore).
- Corso di formazione per l'uso corretto delle scale portatili (4 ore).
- Corso di formazione per l'uso corretto dei trabattelli e ponti mobili (4 ore).
- Accesso con funi ad edifici storici (40 ore)
- Corso di formazione per installatori COUDOU PRO (8 ore)
- Corso di formazione per addetti all'accesso e posizionamento mediante funi IRATA Liv. 1 (40 ore)
- Corso di formazione per addetti all'accesso e posizionamento mediante funi IRATA Liv. 2 (40 ore)
- Corso di formazione per addetti all'accesso e posizionamento mediante funi IRATA Liv. 3 (40 ore)

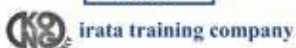

## Directive

2006/42/CEE	Machinery Directive
89/686/CEE	Personal Protective Equipment
93/42/CEE	Medical Devices

## CE NORMS



EN 166		Personal eye protection	Protezione personale degli occhi
EN 341		Descender devices for rescue	Dispositivi di discesa per salvataggio
EN 353-1		Guided type fall arresters including a rigid anchor line	Dispositivi anticaduta di tipo guidato comprendenti una linea di ancoraggio rigida
EN 353-2		Guided type fall arresters including a flexible anchor line	Dispositivi anticaduta di tipo guidato comprendenti una linea di ancoraggio flessibile
EN 354		Lanyards	Cordini
EN 355		Energy absorbers	Assorbitori di energia
EN 358		Belts for work positioning and restraint and work positioning lanyards	Cinture di posizionamento sul lavoro e di trattenuta e cordini di posizionamento sul lavoro
EN 360		Retractable type fall arresters	Dispositivi anticaduta di tipo retrattile
EN 388		Protective gloves against mechanical risk	Guanti di protezione contro i rischi meccanici
EN 361		Full body harnesses	Imbracature per il corpo
EN 362		Connectors	Connettori
EN 363		Personal fall protection systems	Sistemi individuali per la protezione contro le cadute
EN 397		Industrial safety helmets	Elmetti di protezione per l'industria
EN 420		Protective gloves	Guanti di protezione
EN 564	UIAA 102	Accessory cord	Cordino
EN 565	UIAA 103	Tape	Fettuccia
EN 566	UIAA 104	Slings	Anelli
EN 567	UIAA 126	Rope clamps	Bloccanti
EN 568	UIAA 151	Ice anchors	Ancoraggi da ghiaccio
EN 569	UIAA 122	Pitons	Chiodi
EN 795		Anchor devices	Dispositivi di ancoraggio
EN 813		Sit harnesses	Cinture con cosciali
EN 892	UIAA 101	Dynamic mountaineering ropes	Corde dinamiche per alpinismo
EN 893	UIAA 153	Crampons	Ramponi
EN 958	UIAA 128	Energy absorbing systems for use in Klettersteig climbing	Dissipatori d'energia utilizzati nelle ascensioni per via ferrata
EN 959	UIAA 123	Rock anchors	Chiodi da roccia
EN 1496		Rescue lifting devices	Dispositivi di sollevamento per il salvataggio
EN 1498		Rescue loops	Cinghie di salvataggio
EN 1891	UIAA 107	Low stretch kernmantel ropes	Corde con guaina a basso coefficiente di allungamento
EN 12270	UIAA 124	Chocks	Blocchi da incastro
EN 12275	UIAA 121	Connectors	Connettori
EN 12276	UIAA 125	Frictional anchors	Ancoraggi regolabili
EN 12277	UIAA 105	Harnesses	Imbracature
EN 12278	UIAA 127	Pulleys	Pulegge
EN 12492	UIAA 106	Helmets for mountaineers	Caschi per alpinisti
EN 12841		Rope access systems Rope adjustment devices	Sistemi di accesso con fune Dispositivi di regolazione della fune
EN 13089	UIAA 152	Ice-tools	Utensili da ghiaccio
EN 15151-1		Semi-automatic descender devices	Discensori semi-automatici
EN 15151-2		Manual descender devices	Discensori manuali

Many of our products comply also to NFPA, ANSI, NIT, Russian and Brazilian norms.

Molti dei nostri prodotti sono conformi anche alle norme NFPA, ANSI, NIT e specifiche norme Russe e Brasiliane.

The equipment choice is a crucial moment for every professional or employer.

On the following pages you will find some suggestions to make the most suitable kit for your needs.

For special requirements, all kits can be customized.

PPE are supplied in a handy bag - making it easier to transport your equipment to the job, and helping to protect your equipment during storage.

**WARNING!**

Before use, carefully read the information provided by the manufacturer. The following pictures are only used to illustrate concepts, and should not be considered to be the user manual!

La scelta dell'attrezzatura è un momento cruciale per ogni lavoratore autonomo o datore di lavoro.

Nelle seguenti pagine trovate dei suggerimenti per comporre al meglio il kit più idoneo alle vostre esigenze.

Tutti i kit possono essere personalizzati.

I kit sono contenuti in una pratica sacca porta materiale che ne agevola il trasporto e li protegge nel periodo di stoccaggio.

**ATTENZIONE!**

Prima dell'utilizzo è necessario leggere attentamente le informazioni fornite dal fabbricante. Le seguenti illustrazioni hanno una valenza puramente commerciale e pertanto non devono essere considerate un manuale d'uso.



**All kits can be customized.**

Tutti i kit possono essere personalizzati.



**WARNING!**

Carefully read the manufacturer's information. These drawings have only a commercial purpose and must not be considered instructions of use.

**ATTENZIONE!**

Leggere attentamente le informazioni fornite dal fabbricante. Queste illustrazioni hanno una valenza puramente commerciale e pertanto non devono essere considerate un manuale d'uso.





**KITS  
KIT**

**1**



## INDIVIDUAL KIT

In order to facilitate the scaffolding operator in the choice of appropriate PPE for their activities, Kong offers an individual kit that meets the most common needs; the kit can be integrated for special needs.  
**Suggested Training:** Training for mounting, transformation and dismantling of scaffolding (28 hours).

## KIT INDIVIDUALE

Allo scopo di facilitare il ponteggiista nella scelta dei DPI adeguati per la propria attività, Kong propone un kit individuale di base che può soddisfare le esigenze più comuni; il kit può essere integrato per esigenze particolari. **Formazione suggerita:** Corsi di formazione per montaggio, smontaggio e trasformazione ponteggi (28 ore).

Name	n°	pag.
SIERRA DUO (+ QUICK LINK)	1	40
MOUSE WORK	1	29
EAW I SET 150 cm	1	49
OVAL STEEL CLASSIC	1	77
ROPE BAG 100	1	112



SIERRA DUO    MOUSE WORK    EAW I SET    OVAL STEEL CLASSIC    ROPE BAG 100

## TEAM KIT

The assembly, disassembly and processing of scaffolds are operations performed by a team composed of people equipped with their own PPE and with team equipment. Each type of scaffolding has its own characteristics and problems of fall protections; the kit proposed by Kong allows safe operations on most common scaffolding on the market.

## KIT SQUADRA

Il montaggio, lo smontaggio e la trasformazione di ponteggi sono operazioni eseguite da una squadra composta da persone con i propri DPI ma con attrezzatura di squadra. Ogni tipologia di ponteggio ha proprie caratteristiche e problematiche di protezione; il kit proposto da Kong consente di operare in sicurezza sulla maggior parte dei ponteggi presenti sul mercato.

Name	n°	pag.
LIFE LINE	1	63
RETRACTABLE FALL ARRESTER 10 m	1	50
ARO BULL 80	1	58
ARO BULL 120	1	58
OVAL D STEEL	3	77



LIFE LINE    RETRACTABLE FALL ARRESTER    ARO BULL    OVAL D STEEL

## EVACUATION KIT

In case of falling outside of the scaffolding, it is important that the team members take action to remove the colleague from suspension, which, with loss of consciousness, can be fatal within minutes. The evacuation of an injured person must be planned and the team members must be trained to do it correctly and quickly. To carry out the evacuation is necessary to have the proper equipment. Kong offers a kit which is very easy to use and suggests that it is always present in every workplace.

## KIT EVACUAZIONE

In caso di caduta all'esterno del ponteggio, è importantissimo che i restanti componenti la squadra intervengano a togliere il collega dalla sospensione, la quale, se con perdita di conoscenza, può essere mortale nell'arco di pochi minuti. L'evacuazione di un infortunato deve essere pianificata ed i componenti della squadra devono essere addestrati ad eseguirla correttamente e velocemente. Per effettuare l'evacuazione è necessario avere una apposita attrezzatura. Kong propone un kit molto semplice da utilizzare e suggerisce che sia sempre presente in ogni luogo di lavoro.

Name	n°	pag.
KONG LINE 25 m (+438LZYZ)	1	53
INDY EVO PLUS	1	89
X-LARGE CARBON STEEL TWIST LOCK	2	78
WIRE STEEL ROPE 100 cm	1	52
ROPE BAG 100	1	112
ARO BULL 60	1	58
CUTTER	1	

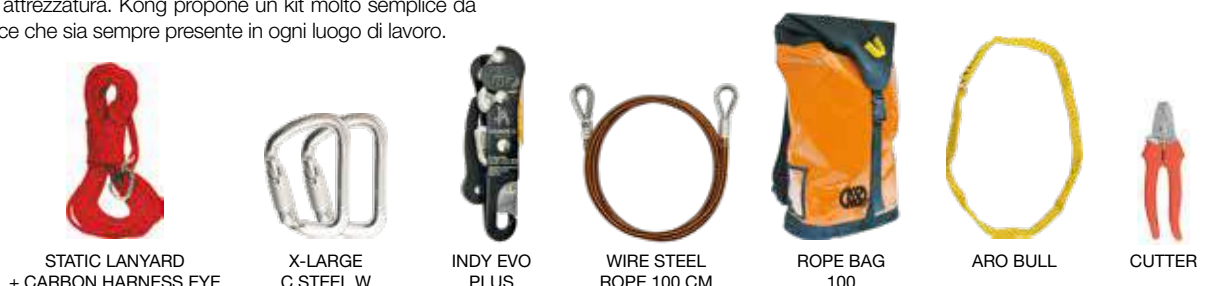

STATIC LANYARD + CARBON HARNESS EYE    X-LARGE C STEEL W    INDY EVO PLUS    WIRE STEEL ROPE 100 CM    ROPE BAG 100    ARO BULL    CUTTER

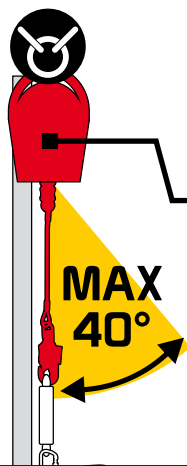

# 225.01  
RETRACTABLE  
FALL ARRESTER

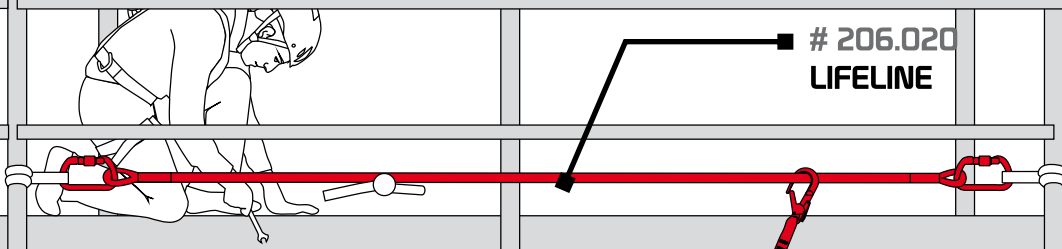

# 206.020  
LIFELINE

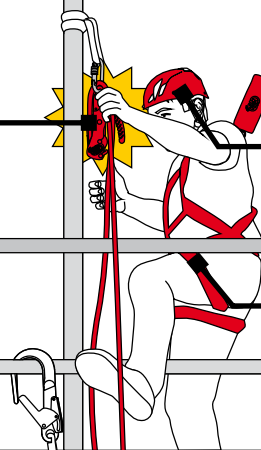
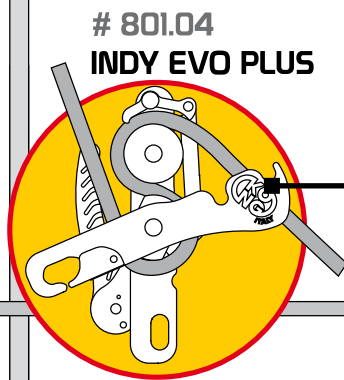

# 201.SET  
EAW SET

# 997.18  
MOUSE WORK

# 8W.032  
SIERRA DUO

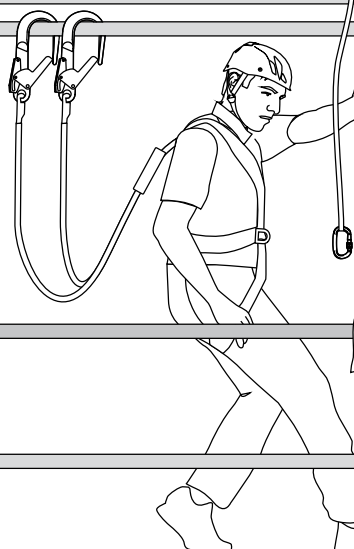

# 278.L06  
STATIC LANYARD

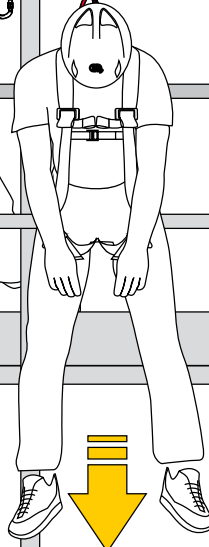

## ROOFS AND INCLINED SURFACES

Working at height on inclined surfaces presents different challenges compared to other situations.

The Kong Roofing Kit is well suited for fall protection while working on most inclined planes. In the case of complex pyramid roofs, a Y lanyard fall arrester or retractable fall arrest must be integrated.

**Suggested Training:** Training for the proper use of fall arrester PPE (4 hours theory and 4 hours of practice).

## TETTI E PIANI INCLINATI

Il lavoro in quota su piani inclinati presenta problematiche diverse rispetto ad altre situazioni.

Il kit proposto da Kong ben si adatta alla maggior parte dei piani inclinati, ma, nel caso di tetti complessi a piramide deve essere integrato con cordino anticaduta a Y o anticaduta retrattile.

**Formazione suggerita:** Corsi di formazione per il corretto utilizzo dei DPI Anticaduta (4 ore teoria e 4 ore di pratica).

Name	n°	pag.
SIERRA DUO (+ QUICK LINK)	1	40
MOUSE WORK	1	29
ARO BULL 80	1	58
ARO BULL 120	1	58
LANYARD STATIC ROPE 15 m	1	53
BACK-UP	1	48
EAW BASE	1	49
OVAL STEEL CLASSIC	1	77
X-LARGE CARBON STEEL	1	78
ROPE BAG 100	1	112



SIERRA DUO



MOUSE WORK

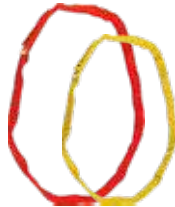

ARO BULL



BACK-UP



EAW BASE



OVAL STEEL CLASSIC



X-LARGE STEEL



LANYARD STATIC ROPE



ROPE BAG 100

## FIXED LIFE LINE

Lifelines are horizontal lines of anchoring, and they are divided into fixed and temporary lifeline. Fixed lifelines must be composed with certified devices, designed by a qualified professional, and put in place by an installer authorized by the manufacturer. They must be tested and inspected at least once a year. For the use of fixed lifelines Kong offers a simple and practical kit.

**Suggested Training:** Training for the proper use of fall arrester PPE (4 hours theory and 4 hours of practice).

## LINEE VITA FISSE

Le linee vita sono linee di ancoraggio orizzontale, si distinguono in linea vita fisse e temporanee. Le linee fisse devono essere composte da dispositivi certificati, progettate da un professionista qualificato, e messe in opera da un posatore autorizzato dal produttore. Devono essere poi collaudate e ispezionate almeno una volta all'anno. Per l'utilizzo delle linee vita fisse Kong propone un kit semplice e funzionale.

**Formazione suggerita:** Corsi di formazione per il corretto utilizzo dei DPI Anticaduta (4 ore teoria e 4 ore di pratica).

Name	n°	pag.
SIERRA DUO (+ QUICK LINK)	1	40
MOUSE WORK	1	29
EAW Y SET 150 cm	1	49
OVAL STEEL CLASSIC	1	77
ROPE BAG 100	1	112



SIERRA DUO



MOUSE WORK



EAW Y SET



OVAL STEEL CLASSIC



ROPE BAG 100

## TEMPORARY LIFE LINE

Temporary lifelines should be positioned where there is no other possibility of creating a suitable anchor point. The positioning requires great skill because the elements of the bond must be very solid and the tension must be that listed by the manufacturer.

**Suggested Training:** Training for the proper use of fall arrester PPE (4 hours 4 hours of theory and practice)

## LINEE VITA TEMPORANEE

Le linee vita temporanee devono essere posizionate dove non esiste altra possibilità di creare un ancoraggio adeguato. Il posizionamento richiede molta competenza poiché gli elementi di vincolo devono essere molto solidi e il tensionamento deve essere nei valori indicati dal produttore.

**Formazione suggerita:** Corsi di formazione per il corretto utilizzo dei DPI Anticaduta (4 ore di teoria e 4 ore di pratica).

Name	n°	pag.
SIERRA DUO (+ QUICK LINK)	1	40
MOUSE WORK	1	29
OVAL STEEL CLASSIC	1	77
OVAL D STEEL	2	77
EAW Y SET 150 cm	1	49
LIFELINE	1	63
ROPE BAG 100	1	112

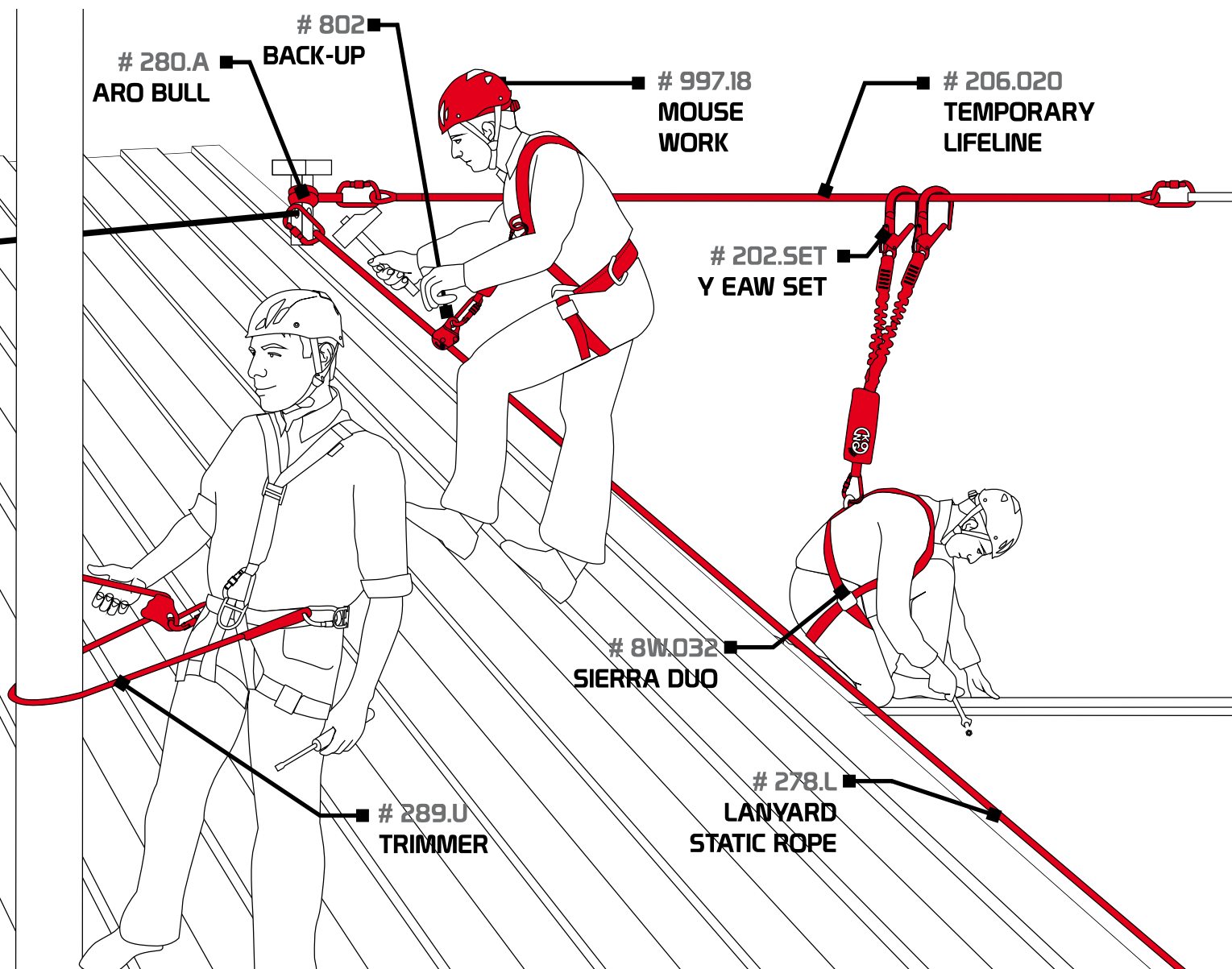
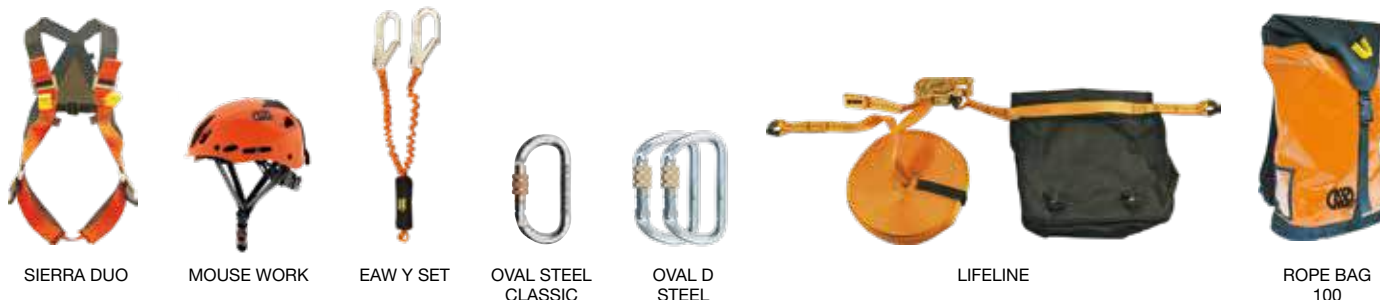

## INDIVIDUAL KIT

Working on metal structures involves stability problems because contact surfaces for the feet are limited. In addition to the fall arrest system, it is necessary to use a positioning system. The kit proposed by Kong also includes a harness with triple certification (EN361, EN358, EN813) in order to make the evacuation as a rescuer in suspension.

**Suggested Training:** Rope access and positioning course (Form A, 32 hours).

## KIT INDIVIDUALE

Lavorare su strutture in carpenteria metallica comporta problemi di stabilità poiché le superfici di appoggio dei piedi sono limitate. In aggiunta al sistema anticaduta è necessario utilizzare un sistema di posizionamento. Il kit proposto da Kong prevede anche una imbracatura con tripla certificazione (EN361, EN358, EN813) per poter effettuare l'evacuazione in qualità di soccorritore in sospensione.

**Formazione suggerita:** Corso per Addetto ai lavori con accesso e posizionamento mediante funi (Modulo A, 32 ore).



EKTOR



MOUSE WORK



EAW Y SET



OVAL STEEL CLASSIC



TRIMMER



ROPE BAG 100

Name	n°	pag.
EKTOR	1	38
MOUSE WORK	1	29
EAW Y SET 150 cm	1	49
OVAL STEEL CLASSIC	3	77
TRIMMER 2 m	1	54
ROPE BAG 100	1	112

## EVACUATION KIT

Metal structures can have the most varied shapes and dimensions. Therefore planning the evacuation of an injured person can be complex and involve the installation of a cable way to retrieve the injured with a suspended rescuer.

**Suggested Training:** Rope access and positioning course (Form A, 32 hours).

## KIT EVACUAZIONE

Le strutture metalliche possono avere le forme più variegata pertanto la pianificazione dell'evacuazione di un infortunato può essere complessa e comportare l'allestimento di una teleferica o di recuperare l'infortunato con un soccorritore in sospensione.

**Formazione suggerita:** Corso per Addetto ai lavori con accesso e posizionamento mediante funi (Modulo A, 32 ore)



WIRE STEEL  
ROPE 100 CM



4RIG



INDY EVO PLUS



CUTTER



EXTRA ROLL



BACK-UP



EAW BASE



X LARGE C. STEEL AB



OVAL STEEL  
CLASSIC



ROPE BAG 100

Name	n°	pag.
WIRE STEEL ROPE 100 cm	1	52
4RIG	1	62
X-LARGE CARBON STEEL AUTO BLOCK	6	78
INDY EVO PLUS	1	89
EXTRA ROLL	1	102
BACK-UP	1	48
EAW BASE	1	49
OVAL STEEL CLASSIC	2	77
CUTTER	1	
ROPE BAG 100	1	112

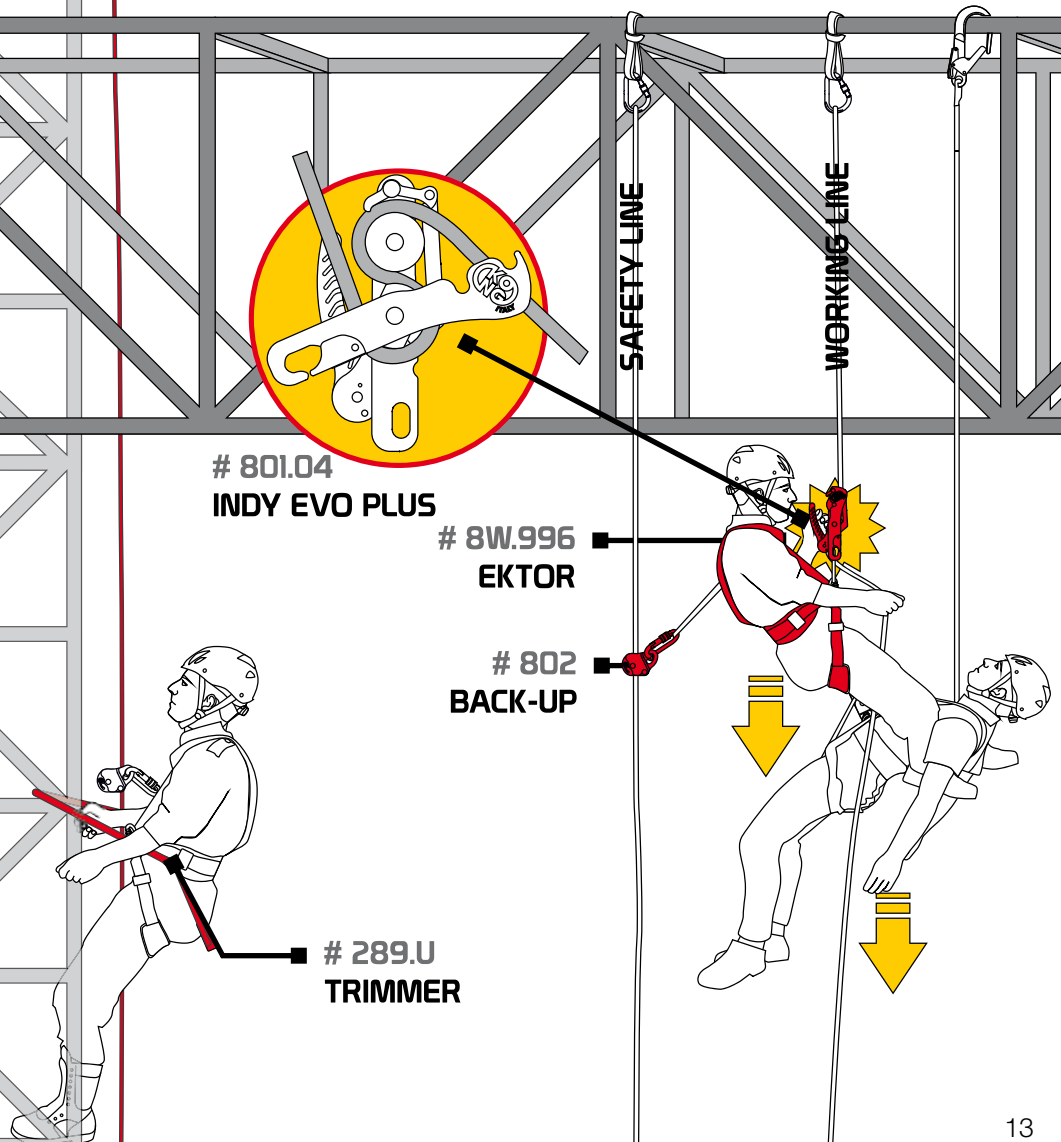
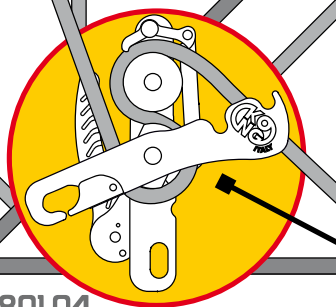
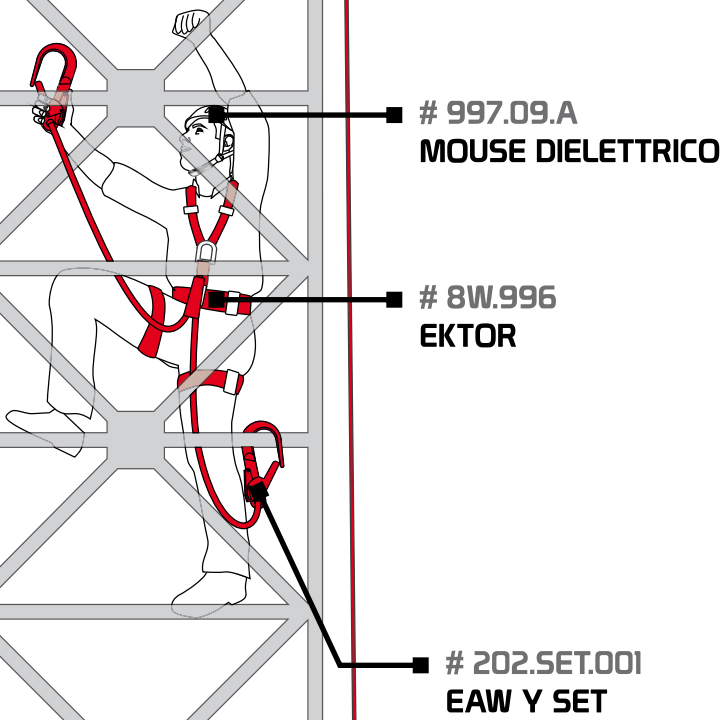

## INDIVIDUAL KIT

Technically it is more correct to define it as “temporary work at height and access/positioning on ropes.” This kind of work, because of its complexity, can only be carried out for short periods of time or if it is not possible to use another system.

It can only be done by people who have had specific training and certification.

**Suggested Training:** Rope access and positioning course (Form A, 32 hours).

## KIT INDIVIDUALE

Tecnicamente è più corretto definirli “lavori temporanei in quota con accesso e posizionamento mediante funi”. Sono lavori che a causa della complessità, possono essere realizzati solo se sono di breve durata o se è impossibile usare sistemi diversi.

Possano essere effettuati solo da persone che hanno avuto una formazione specifica con abilitazione finale.

**Formazione suggerita:** Corso per Addetto ai lavori con accesso e posizionamento mediante funi (Modulo A, 32 ore).

Name	n°	pag.
EKTOR	1	38
HAMMOCK	1	41
MOUSE WORK	1	29
ARO BULL 80	1	58
ARO BULL 120	1	58
WIRE STEEL ROPE 160 cm	1	52
4RIG	1	62
X-LARGE CARBON STEEL AUTO BLOCK	6	78
QUICK LINK	1	85
INDY EVO PLUS	1	89
BACK-UP	1	48
EAW BASE	1	49
OVAL STEEL CLASSIC	2	77
Y RESCUE	1	59
FUTURA HAND (pair)	2	96
SLING ASCENDER	1	97
WORK BAG	1	114



EKTOR



HAMMOCK



MOUSE WORK



ARO BULL



WIRE STEEL  
ROPE 100 CM



4RIG



X LARGE  
C. STEEL AB



QUICK LINK



INDY EVO PLUS



BACK-UP



OVAL STEEL  
CLASSIC



EAW BASE



Y RESCUE



FUTURA HAND



SLING ASCENDER



WORK BAG



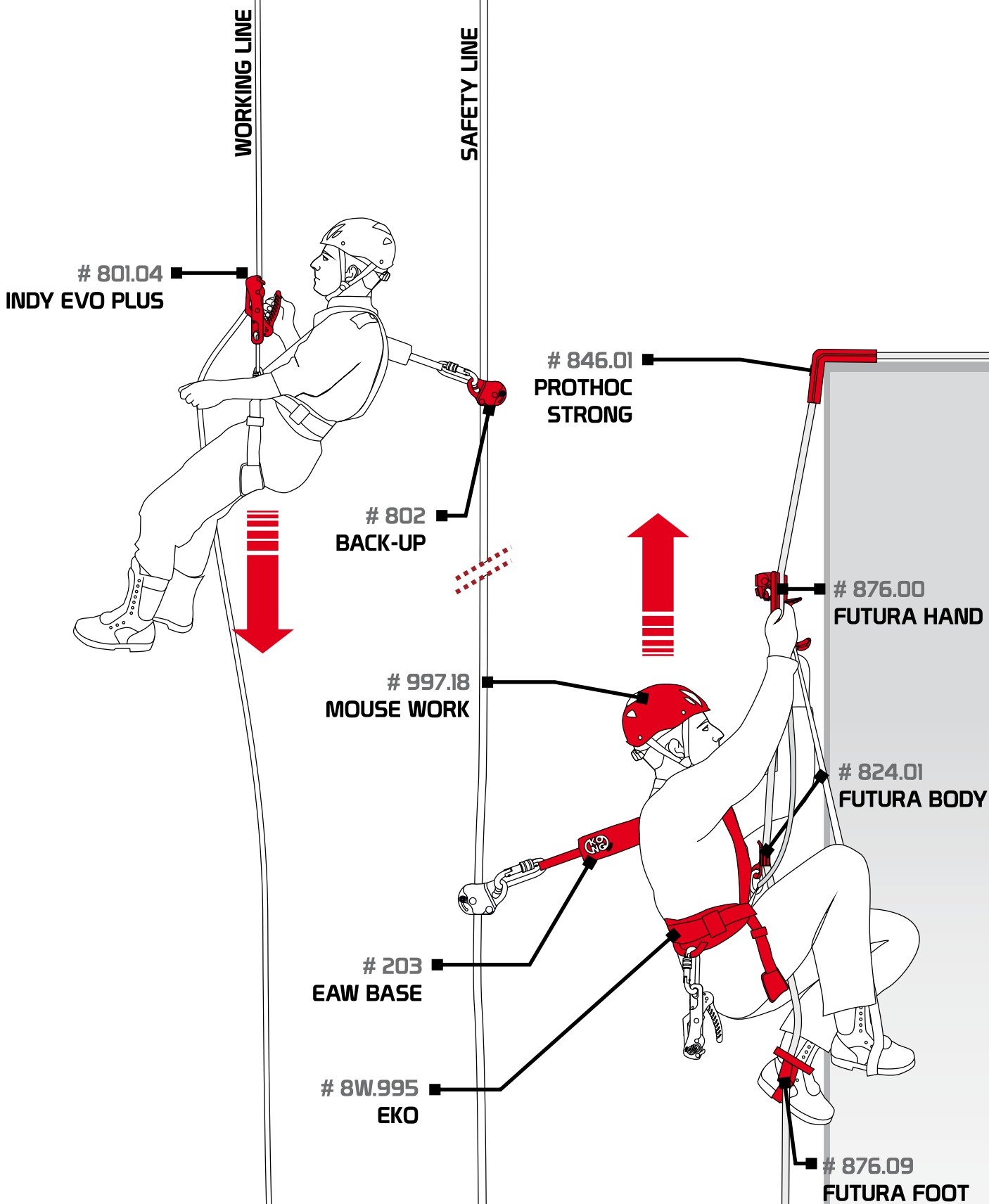

## OPERATOR ON THE GROUND KIT

Evacuation from cable ways, increasingly used more and more even in the summer season, is an operation that must be performed by structure management staff. It's a tricky procedure that must be implemented quickly and without the possibility of error.

**Suggested Training:** Rope access and positioning course (Form A, 32 hours).

## KIT OPERATORE A TERRA

L'evacuazione dagli impianti a fune, sempre più spesso utilizzati anche nella stagione estiva oltre a quella invernale, è un'operazione che deve essere effettuata dal personale del gestore. E' una procedura delicata che deve essere messa in atto senza possibilità di errore e in tempi rapidissimi.

**Formazione suggerita:** Corso per Addetto ai lavori con accesso e posizionamento mediante funi (Modulo A, 32 ore).

Name	n°	pag.
EKO	1	39
MOUSE WORK	1	29
OVAL STEEL CLASSIC	1	77
INDY EVO PLUS	1	89
ROPE BAG 100	1	112



## ON LINE OPERATOR KIT KIT OPERATORE IN LINEA



EKO



MOUSE WORK



Y ARO SPELEO



TRIANGLE QUICK LINK



FERRATA TW



OVALONE TW



ROPE BAG 100

Name	n°	pag.
EKO	1	39
MOUSE WORK	1	29
Y ARO SPELEO	1	59
TRIANGLE QUICK LINK	1	85
FERRATA TWIST LOCK	2	81
OVALONE TWIST LOCK	1	74
ROPE BAG 100	1	112

## TEAM KIT KIT SQUADRA



REFLEX



QUICK LINK



ROLLEY



QUEEDY



OVALONE CARBON TW



ARO SLING TUBULAR



PEGASUS



WORK BAG

Name	n°	pag.
REFLEX	1	102
QUICK LINK	1	85
ROLLEY	1	104
QUEEDY	1	83
OVALONE TWIST LOCK	3	74
ARO SLING TUBULAR 80	1	58
PEGASUS	1	42
WORK BAG	1	114

\* Alternatively, you can use Ortis descender  
In alternativa si può utilizzare il discensore Ortis

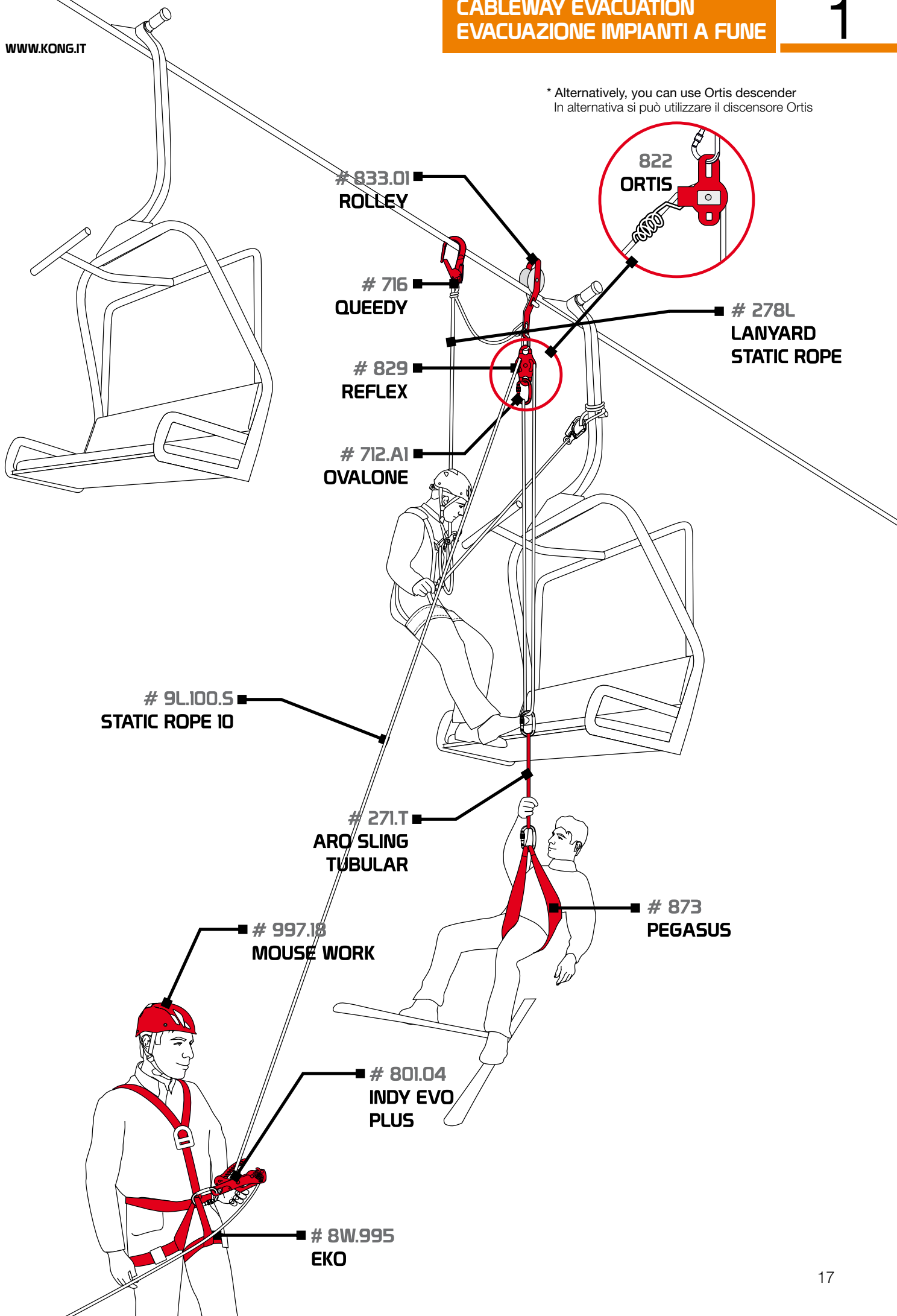

**WORK AND EVACUATION KIT**

Confined Space is any restricted environment. Here the risk of serious injury or death can often be very high, due to the presence of substances or dangerous conditions (eg. Lack of oxygen).

Confined spaces are easily identifiable because of the presence of small openings, as in the case of tanks, silos, containers which are used in reactors, closed drainage systems, sewer systems.

Other types of confined spaces, not as easy to identify but equally dangerous, could be: open cisterns, tanks, combustion chambers in furnaces, pipelines, areas with inadequate or absent ventilation.

Kong offers a kit for the movement of the worker both in normal operations and in case of evacuation. For rappelling more than 2 meters, the use of a descender device conforming to CE standard EN 341 is compulsory (INDY EVO PLUS # 801.04).

**Suggested Training:** Training for confined spaces (24 hours).

**KIT LAVORO ED EVACUAZIONE**

Per ambiente confinato si intende un qualsiasi ambiente limitato, in cui il pericolo di morte o di infortunio grave è molto elevato, a causa della presenza di sostanze o condizioni di pericolo (ad es. mancanza di ossigeno). Gli ambienti confinati sono facilmente identificabili proprio per la presenza di aperture di dimensioni ridotte, come nel caso di serbatoi, silos, recipienti adibiti a reattori, sistemi di drenaggio chiusi, reti fognarie. Altri tipi di ambienti confinati, non altrettanto facili da identificare ma ugualmente pericolosi, potrebbero essere: cisterne aperte, vasche, camere di combustione all'interno di forni, tubazioni, ambienti con ventilazione insufficiente o assente.

Kong propone un kit per la movimentazione del lavoratore sia nella normale operatività che in caso di evacuazione.

Per calate superiori ai 2 metri, è obbligatorio l'utilizzo di un discensore conforme alla norma CE EN 341 (INDY EVO PLUS # 801.04).

**Formazione suggerita:** Corso di formazione ambienti confinati (24 ore).

Name	n°	pag.
CEVEDALE MONO	1	64
SIERRA DUO (+QUICK LINK)	1	40
MOUSE WORK	1	29
BACK-UP	1	48
EAW BASE	1	49
OVAL STEEL CLASSIC	1	77
ROPE BAG 100	1	112
INDY EVO PLUS	1	89



CEVEDALE MONO



SIERRA DUO



MOUSE WORK



LANYARD  
STATIC ROPE



BACK-UP



EAW BASE



OVAL STEEL  
CLASSIC



ROPE BAG 100



INDY EVO PLUS

# 890010000KK

**ROLLY**

Rollable stretcher studied for rescue situations in confined spaces. It is an extremely flexible rescue system, usable when evacuation and patient transport is needed in morphological and difficult climatic situations and therefore a rapid recovery is required.

Barella rollabile stata studiata per adattarsi perfettamente alle esigenze di soccorso in ambienti confinati. Si tratta di un sistema di salvataggio estremamente flessibile, utilizzabile quando è necessaria l'evacuazione e il trasporto del paziente in situazioni morfologiche e climatiche difficili e quindi è richiesto un recupero rapido.

More info here  
Maggiori informazioni



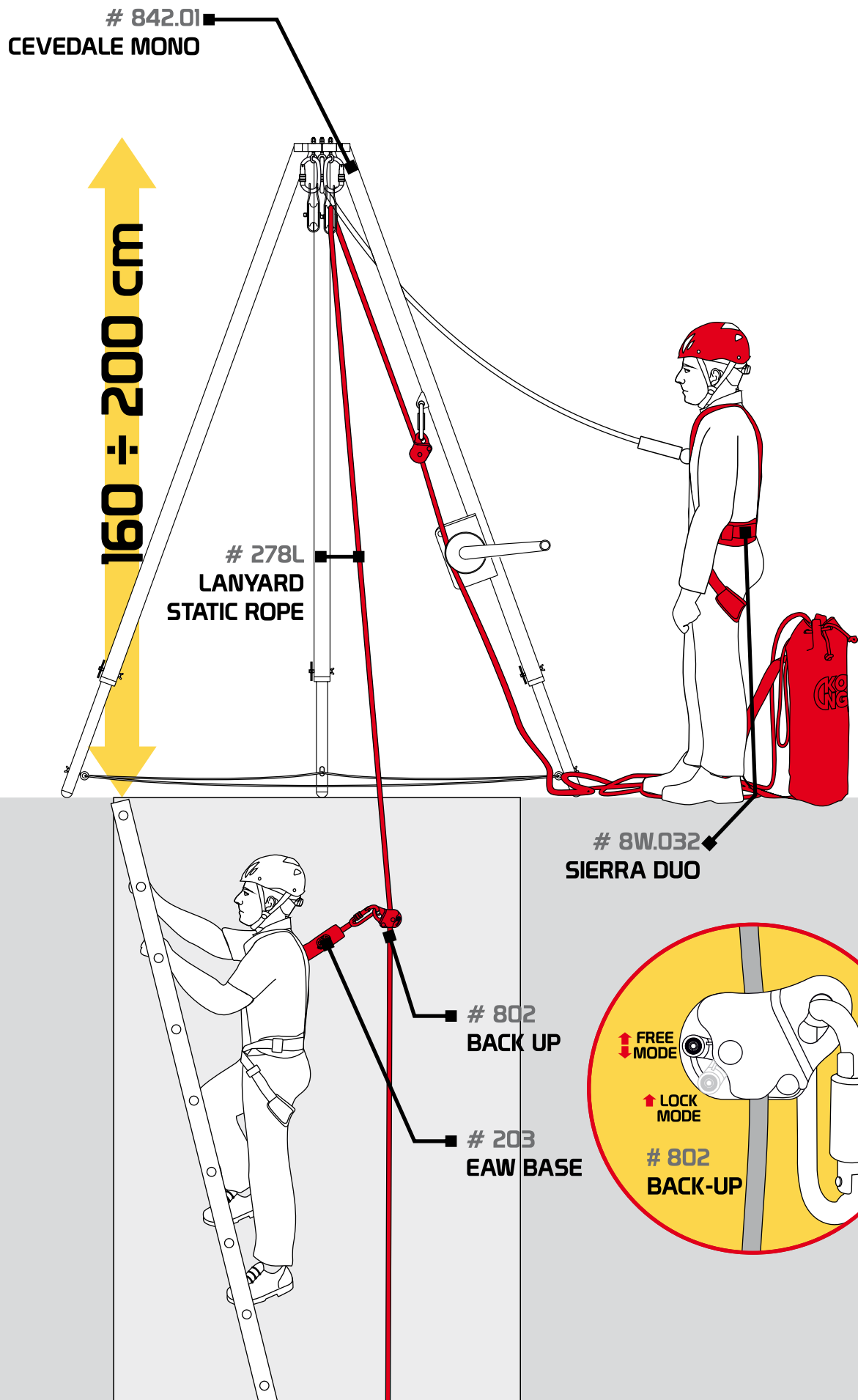

## PORTABLE LADDERS

The recent operative guidelines provides it is possible to work standing on a portable ladder, even if with very strict conditions.

The ladder, if positioned as indicated by the manufacturer, has sufficient stability to be used as a positioning system constraint.

The kit for ladders is not a fall arrester but a positioning system that can free up both hands.

**Suggested Training:** Training course for the correct use of portable ladders (4 hours).

## SCALE PORTATILI

Le recenti indicazioni operative prevedono che stando sulla scala portatile sia possibile, seppur a ben precise condizioni, effettuare lavorazioni. La scala, se posizionata come indicato dal produttore, ha sufficiente stabilità per poter essere utilizzata come elemento di vincolo di un sistema di posizionamento. Il kit per scale portatili non è un sistema anticaduta ma un sistema di posizionamento che consente di liberare entrambe le mani.

**Formazione suggerita:** Corso di formazione per l'uso corretto delle scale portatili (4 ore).



SAFETY BELT

MOUSE WORK

TRIMMER

Name	n°	pag.
SAFETY BELT	1	41
MOUSE WORK	1	29
TRIMMER 2 m	1	54
OVAL STEEL CLASSIC	2	77
ROPE BAG 100	1	112



OVAL STEEL CLASSIC



ROPE BAG 100

## MOBILE ELEVATING WORK PLATFORMS (MEWP)

The boom of elevating work platforms, better known as EWP technical platforms or baskets, has introduced new working practices and new security issues. Only fall protections devices are used on EWPs, but not positioning devices.

**Suggested Training:** Training for using elevating work platforms with and without stabilizers (10 hours).

## PIATTAFORME DI LAVORO ELEVABILI (PLE)

Il boom delle piattaforme di lavoro elevabili, tecnicamente PLE ma meglio conosciute come piattaforme o cestelli, ha introdotto nuove procedure di lavoro e nuove problematiche di sicurezza. Su PLE non si utilizzano dispositivi di posizionamento ma solo dispositivi anticaduta.

**Formazione suggerita:** Corso di formazione ed addestramento utilizzo PLE con e senza stabilizzatori (10 ore).



SIERRA DUO



MOUSE WORK



ROPE BAG 100

Name	n°	pag.
SIERRA DUO (+QUICK LINK)	1	40
MOUSE WORK	1	29
SET PLE 04	1	21
ROPE BAG 100	1	112



SET PLE 04

**!** Alternatively, choose your set at page 21.  
In alternativa scegli il set a pagina 21.

or or or

SET PLE

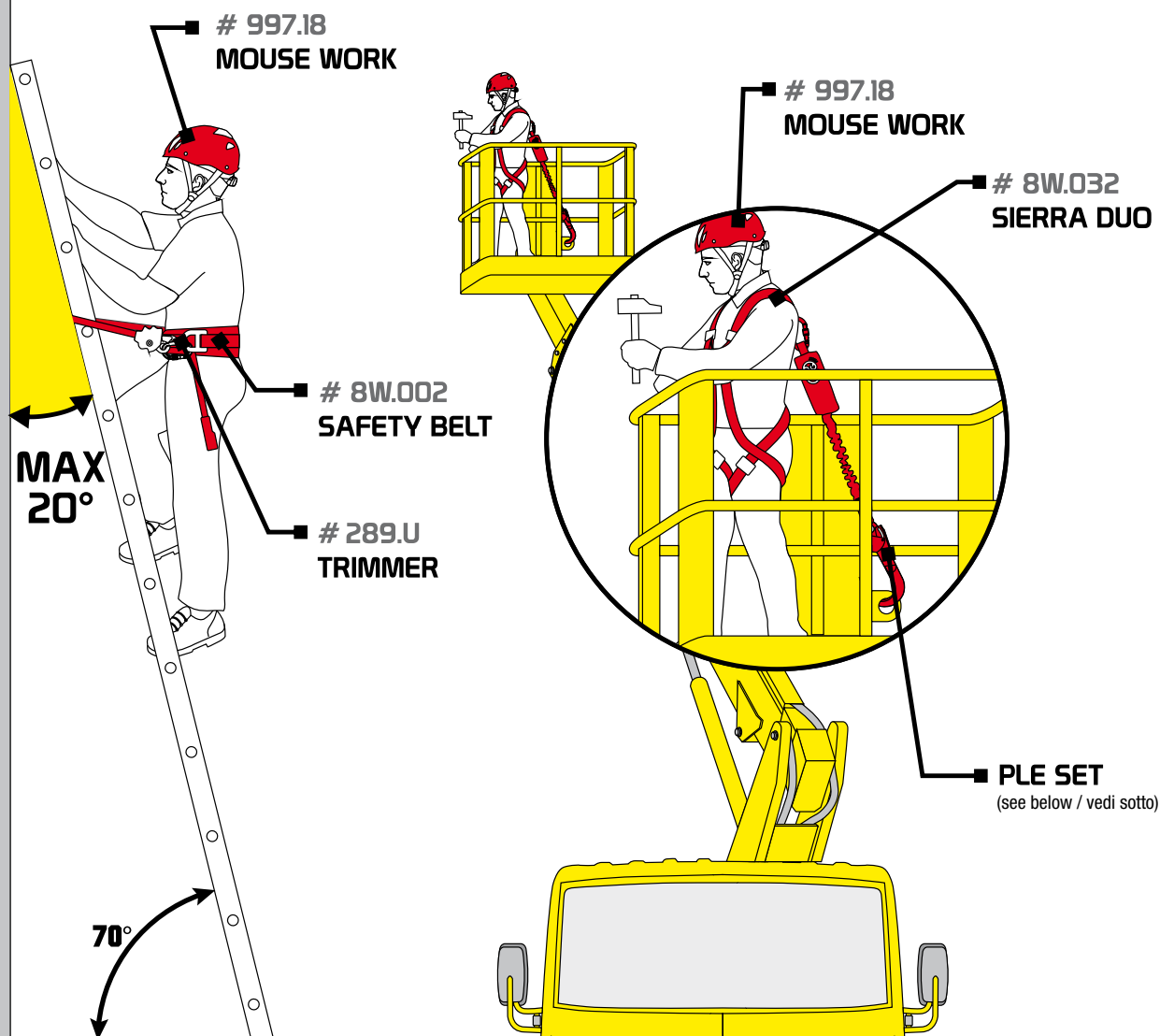

### SET PLE 01

# 225020020KK

CE	g	Size max cm
EN 360	900	200

Features:

- retractable fall arrester with integrated absorber
- must be installed on the platform by the manufacturer or from the property
- best solution for rentals as it automatically adjusts to the height of the operator

Caratteristiche:

- anticaduta retrattile con dissipatore integrato
- deve essere installato sulla piattaforma dal costruttore o dalla proprietà
- soluzione ideale per noleggi in quanto si adatta automaticamente alla statura dell'operatore



### SET PLE 02

# 982SET040KK

CE	g	Size max cm
EN 354 EN 355	1000	145

Features:

- adjustable webbing with integrated energy absorber
- requires operator diligence in regulating the sling, as it must be tight
- worn parts can be replaced, extending the product lifetime

Caratteristiche:

- fettuccia regolabile con dissipatore tessile assemblato
- richiede il diligente intervento dell'operatore nella regolazione della fettuccia poiché deve essere ben tesa
- permette la sostituzione delle parti usurate allungandone la durata



### SET PLE 03

# 982SET041KK

CE	g	Size max cm
EN 353/2 EN 355	1200	180

Features:

- adjustable static lanyard with integrated textile energy absorber
- wide range of adjustment
- the components can also be used in other work situations and replaced in case of wear
- quick adjustment of the length
- possibility of assembling connectors of different sizes according to the type of anchor point

Caratteristiche:

- lunga statica con regolatore anticaduta e dissipatore tessile assemblato
- ampia possibilità di regolazione
- i componenti possono essere utilizzati anche in altre situazioni di lavoro e sostituiti in caso di usura
- regolazione rapida della lunghezza
- possibilità di montare connettori di diverse misure in base al tipo di punto d'ancoraggio

### SET PLE 04

# 982SET042KK

CE	g	Size max cm
EN 353/2 EN 355	1430	190

## SAILBOAT MASTS

Both during construction and during maintenance of sailing boats, it is often necessary to get an operator on the mast. Kong offers a complete kit for any operation of this kind. The security rope must be at least twice the height of the mast.

**Suggested Training:** For employees, rope access Basic + Form A / natural and artificial sites (12+20 hours) or Rope access training for sailboat owners (16 hours).

## ALBERO IMBARCAZIONI A VELA

Sia durante la costruzione che durante la manutenzione delle imbarcazioni a vela spesso è necessario far salire un operatore sull'albero. Kong propone un kit completo per qualsiasi operazione di questo genere. La fune di sicurezza deve essere lunga almeno il doppio dell'altezza dell'albero.

**Formazione suggerita:** Addetti Lavori su funi Base+Modulo A / Siti naturali e artificiali (12+20 ore) oppure Corso funi per armatori barche a vela (16 ore).

Name	n°	pag.
EKTOR	1	38
HAMMOCK	1	41
MOUSE WORK	1	29
ARO BULL 80	1	58
ARO BULL 120	1	58
X-LARGE CARBON STEEL AUTO BLOCK	6	78
INDY EVO PLUS	1	89
BACK-UP	1	48
EAW BASE	1	49
OVAL STEEL CLASSIC	2	77
Y RESCUE	1	59
LIFT (pair)	2	95
SLING ASCENDER	1	97
QUICK LINK	1	85
WORK BAG	1	114



EKTOR



HAMMOCK



MOUSE WORK



ARO BULL



X LARGE  
C. STEEL AB



INDY EVO PLUS



BACK-UP



EAW BASE



OVAL STEEL  
CLASSIC



Y RESCUE



LIFT



SLING ASCENDER



QUICK LINK



WORK BAG

# 21900000KK

## SAFE MAST CLIMBING KIT

Innovative kit that allows the mast to be climbed using 10 mm ropes certified according to EN 1891 to support a human load, instead of uncertified halyards.

Innovativo kit che permetta la risalita in testa d'albero utilizzando funi con diametro di 10 mm certificate secondo la norma EN 1891 per sostenere un carico umano, anziché drizze non omologate.

More info here  
Maggiori informazioni





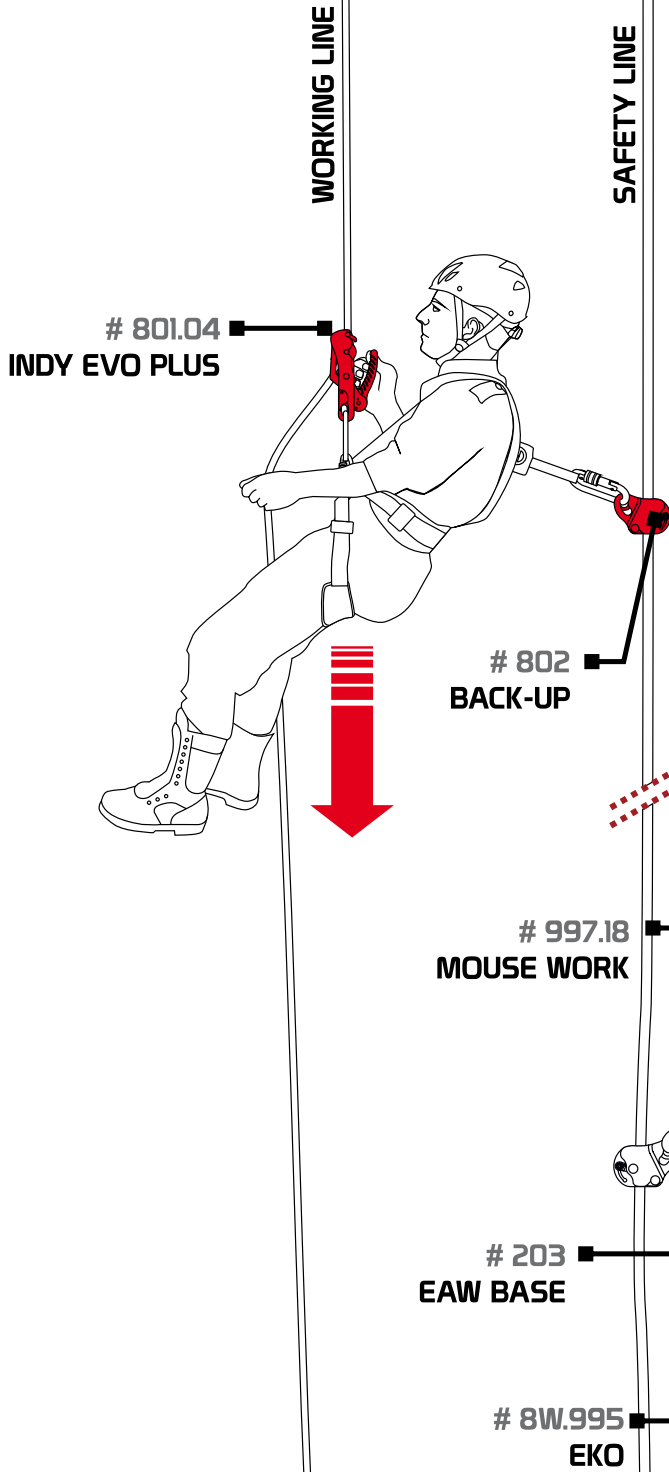

**FOCUS ON SUSPENSIONS**   
**APPROFONDIMENTO SULLE SOSPENSIONI**

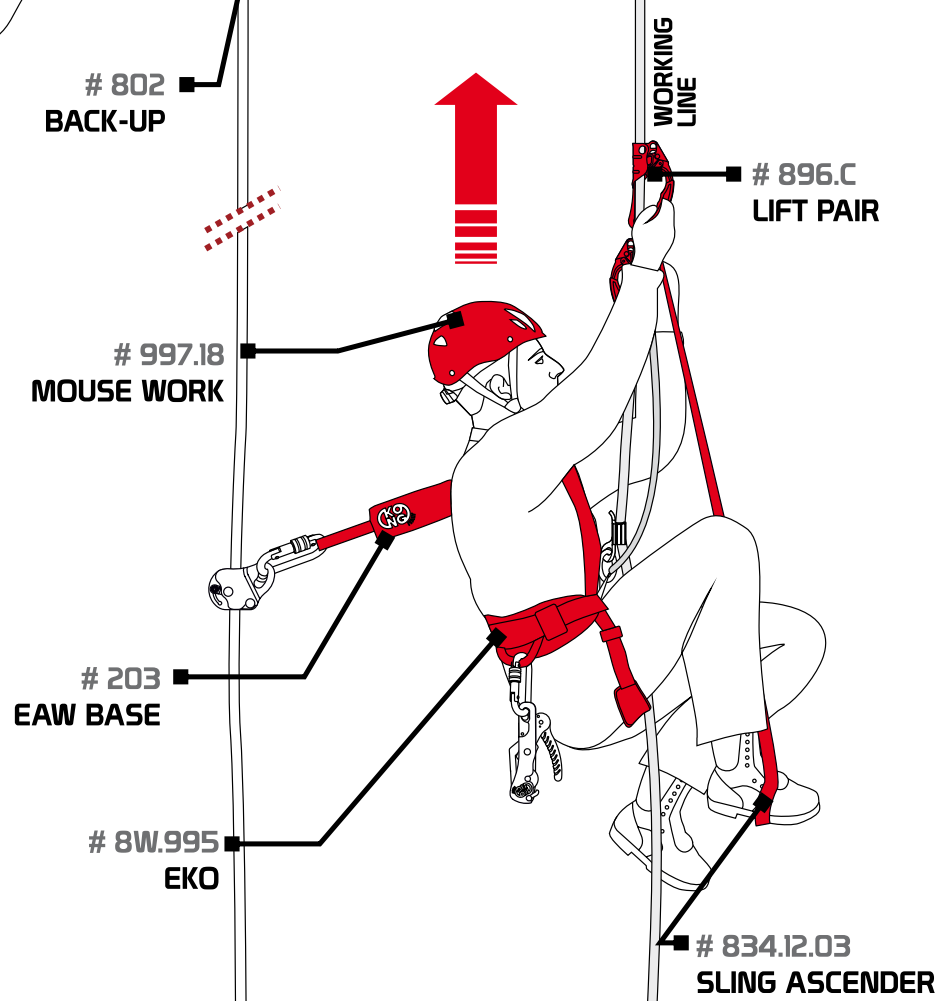
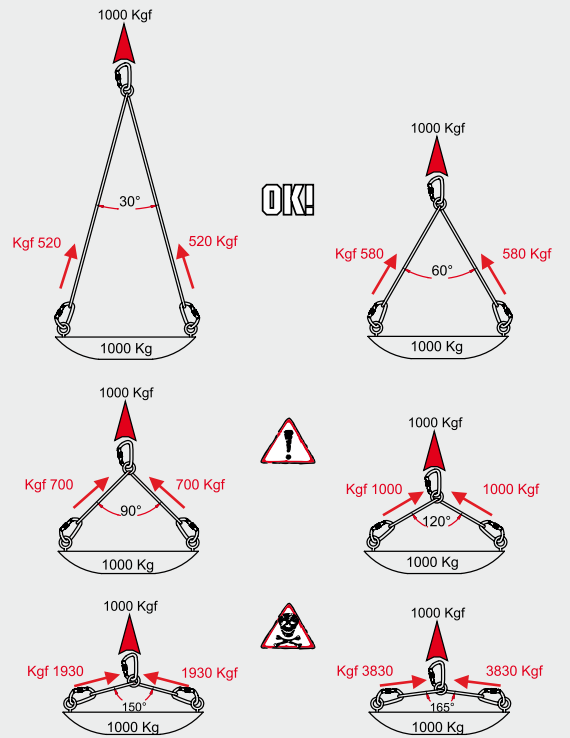

## TREE CLIMBING

Tree climbing or arboriculture, is a work technique which provides access to the crown of the tree and safe movement from branch to branch. This technique allows actions to be performed from inside the crown, where operators of aerial platforms and cranes can not reach. It permits cutting operations, either by hand or with the aid of chainsaws, in the exact desired spot.

**Suggested Training:** Employees for rope access Form A / natural and artificial sites (32 hours).

## ARBORICULTURA

L'arrampicata su albero, o tree climbing, è una tecnica di lavoro che consente di accedere alla chioma dell'albero e muoversi, in sicurezza passando da un ramo all'altro.

La tecnica di arrampicata sugli alberi è principalmente impiegata per eseguire operazioni di potatura, abbattimento, consolidamento. Questa tecnica consente di eseguire gli interventi dall'interno della chioma arrivando, così, dove gli operatori su piattaforme elevatrici ed autogru non possono arrivare e avendo la possibilità di operare i tagli, a mano o con il supporto di motoseghe, nel punto esatto.

**Formazione suggerita:** Addetti Lavori su funi Modulo B/Alberi (32 ore).

Name	n°	pag.
EKO	1	39
MOUSE WORK	1	29
NO CUT ADJUSTABLE LANYARD 3 m	1	52
ARO BULL 120	1	58
TREE FORK	1	58
4RIG	1	62
X-LARGE CARBON STEEL AUTO BLOCK	6	78
INDY EVO PLUS	1	89
BACK-UP	1	48
EAW BASE	1	49
OVAL STEEL CLASSIC	2	77
Y RESCUE	1	59
TRENDER	1	94
SLING ASCENDER	1	97
QUICK LINK	1	85
WORK BAG	1	114



EKO



MOUSE WORK



ARO BULL



TREE FORK



X LARGE  
C. STEEL AB



TRENDER



INDY EVO PLUS



BACK-UP



EAW BASE



OVAL STEEL  
CLASSIC



Y RESCUE



SLING ASCENDER



QUICK LINK



4RIG



ADJUSTABLE STEEL  
LANYARD



WORK BAG

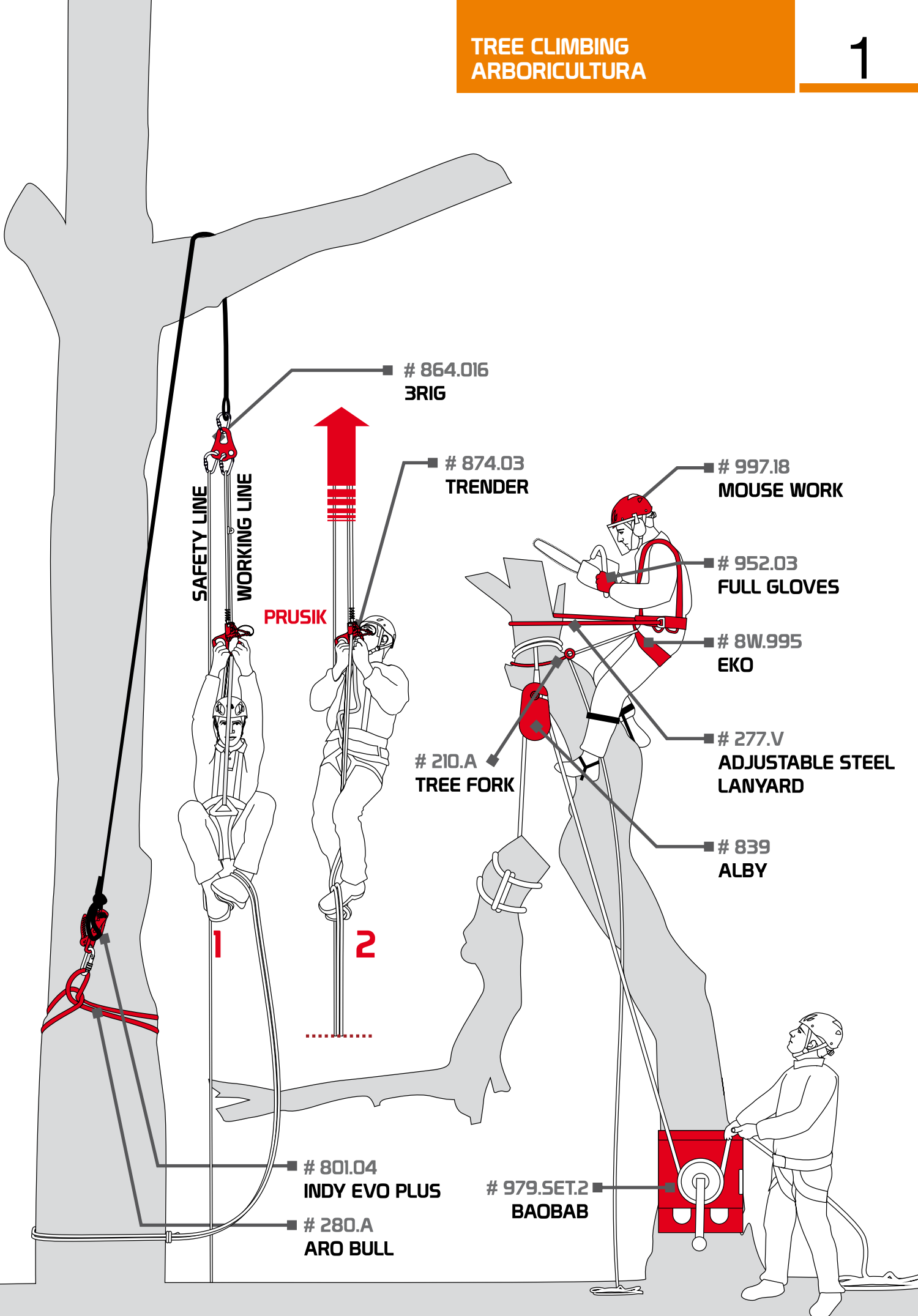

# 2

## Why choose a Kong helmet?

- The WORK versions are certified CE EN 397
- Highly customizable thanks to the optional accessories (headsets, visor, etc.).
- Available in various versions (Sport, Work, Dielectric, and High Visibility)
- Antibacterial padding is removable and washable
- 6 different colors!
- Anti-suffocation chin strap
- Can be customized with your logo and corporate colors
- Produced in Italy!

## Perché scegliere un casco Kong?

- È prodotto in Italia
- È disponibile in varie versioni (Sport, Work, Dielettrico, Alta Visibilità)
- È altamente personalizzabile grazie agli accessori opzionali (cuffie, visiera, ecc.)
- È disponibile in vari colori
- La versione WORK è certificata EN 397
- È dotato di cinturino anti soffocamento
- Ha l'imbottitura antibatterica rimovibile e lavabile
- Per quantitativi minimi può essere personalizzato con loghi e colori istituzionali del cliente



Rope access training course (Pescara - Italy) - ph: Ettore Togni



Spin



Mouse Work



Mouse HV



Ampere



Visors



Earmuffs

## SPIN ANSI

**NEW**

- New professional shock-absorbing helmet.
- Conforms to ANSI Z89.1-2009.
- Comfortable and well-ventilated interior that also guarantees a perfect fit. Removable and washable padding.
- Visor and headphones can be mounted using the integrated clasp on the shell.
- Equipped with 4 durable clips for mounting headlamps.
- UNI Size, just 385g!
- Nuovo casco professionale ultra-resistente agli urti e alle sollecitazioni.
- Certificazione ANSI Z89.1-2009.
- Interno confortevole e ben aereato che garantisce una perfetta calzata; imbottitura removibile e lavabile.
- Permette il montaggio di visiera e cuffie grazie all'innesto integrato nella calotta.
- Dotato di 4 resistenti fermalampada per il montaggio di lampade frontali.
- Taglia UNI, peso contenuto in soli 385g!

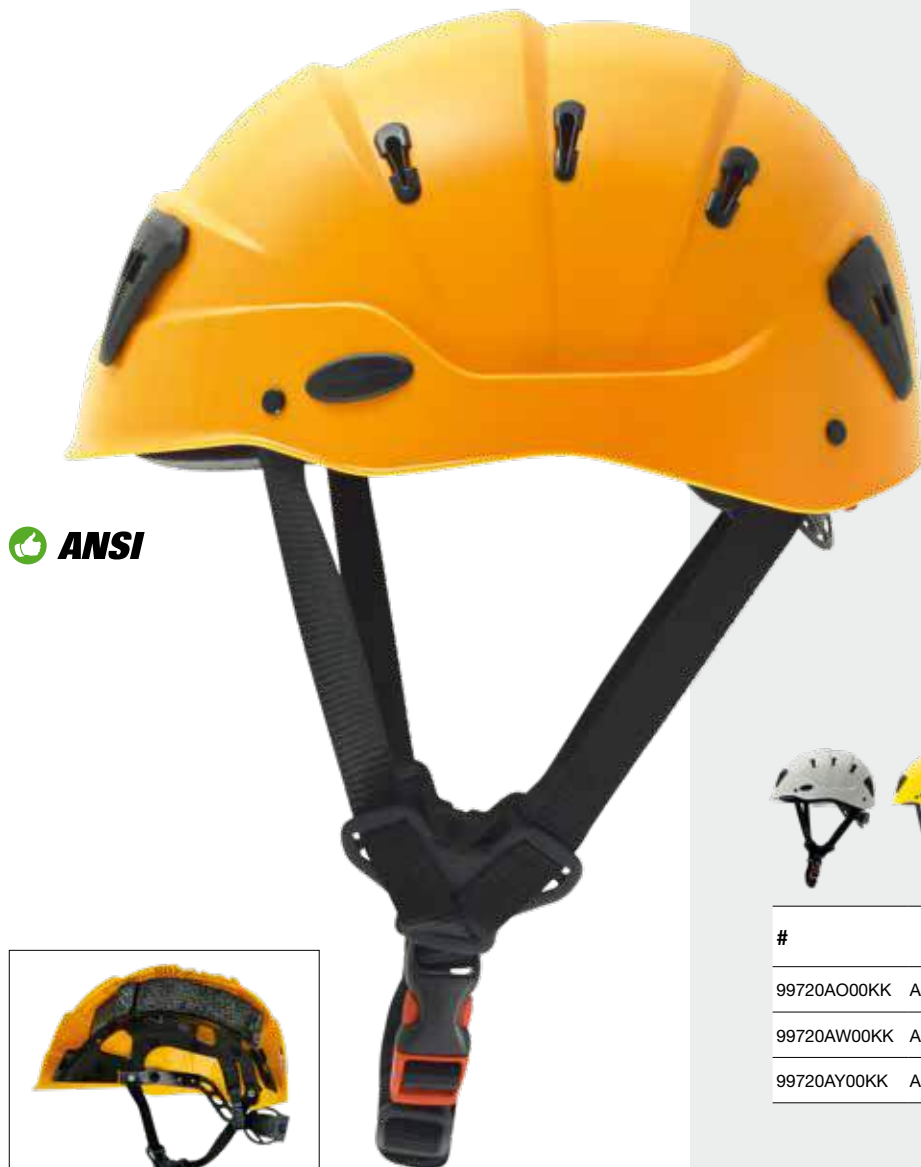

**ANSI**



#	CE	Material	Color	Weight g	Size	cm
99720AO00KK	ANSI Z89.1-2009	ABS	Orange	385	UNI	55/63
99720AW00KK	ANSI Z89.1-2009	ABS	White	385	UNI	55/63
99720AY00KK	ANSI Z89.1-2009	ABS	Yellow	385	UNI	55/63



#	CE	Material	Color	g	Size	cm
99718AN02KK	EN 397	ABS	■	385	UNI	52/64
99718AO02KK	EN 397	ABS	■	385	UNI	52/64
99718AR02KK	EN 397	ABS	■	385	UNI	52/64
99718AW02KK	EN 397	ABS	□	385	UNI	52/64
99718AY02KK	EN 397	ABS	■	385	UNI	52/64
99718GN02KK	EN 397	ABS	■ soft touch	390	UNI	52/64
99718AA02KK	EN 397	ABS	■	390	UNI	52/64

## MOUSE WORK

- Safety helmet for work at height, industrial activities and building construction.
- Chinstrap designed to open in the event of suspension and prevent choking: it opens between 15 and 25 daN (conform to CE EN 397 standard).
- Size adjustment wheel is easy to handle, even with gloves on.
- Shell with ventilation holes.
- Clips for mounting headlamps.
- Pre-drilled holes for the installation of the visor and ear muffs and radio.
- Internal webbing suspension system with removable and washable padding.
- Casco per la sicurezza sul lavoro, per industria ed edilizia.
- Sottogola progettata per aprirsi in caso di urto ed evitare il soffocamento: si apre tra i 15 e i 25 daN (norma caschi industria EN 397).
- Rotella di regolazione del girotesta facilmente regolabile anche con i guanti.
- Calotta dotata di fori d'aerazione.
- Ganci di posizionamento per il montaggio di una lampada frontale.
- Calotta pre-forata per l'installazione di visiera e cuffie antirumore e radio.
- Sistema interno a "ragno" con imbottitura removibile e lavabile.

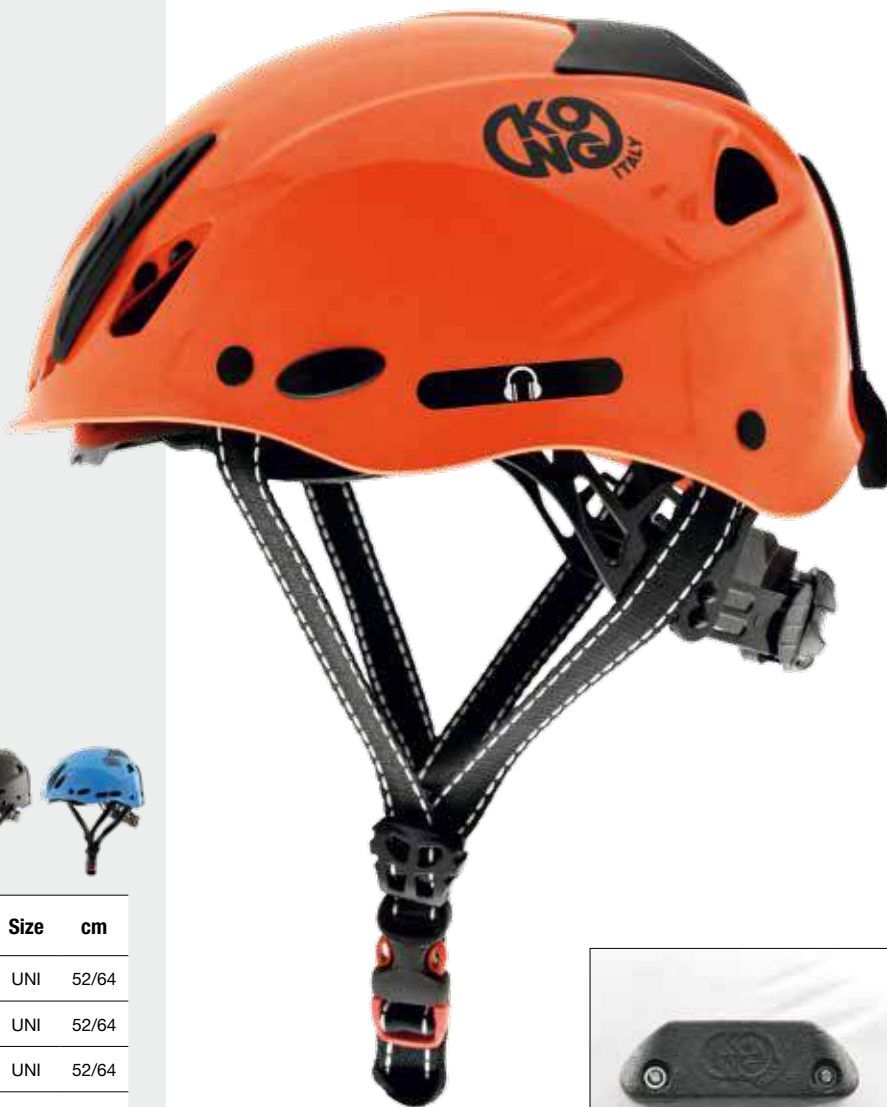

# 997051N00KK  
Plates for earmuff  
Piastra per cuffie

## MOUSE HV High visibility/Alta visibilità

- Special colour Yellow Fluo with reflective stickers. Spare stickers are available for customizing all the other MOUSE colors. .
- With pre-marked holes for mounting headphones (using the special plate # 997.051) and Visor # 997.056.
- Speciale colorazione giallo fluo con adesivi rifrangenti. Gli adesivi possono essere forniti separati per personalizzare gli altri colori del MOUSE.
- Con fori pre-segnati per il fissaggio delle cuffie utilizzando l'apposita piastrina # 997.051 e per il montaggio della visiera # 997.056.



**Anti-choking chin strap automatic release between 15 dN and 25 dN conforms to CE EN 397.**

Sottogola anti-soffocamento a sgancio automatico tra 15 dN e i 25 dN conforme alla norma CE EN 397.

#	CE	Material	Color	g	Size	cm
99718FY02KK	EN 397	ABS	reflective	385	UNI	52/64
99718FW02KK	EN 397	ABS	reflective	385	UNI	52/64
99718FR02KK	EN 397	ABS	reflective	385	UNI	52/64





## AMPERE

**NEW**

- Dielectric helmet with insulation up to 1000 volts.
- Equipped with quick release buckle and adjustable and removable chinstrap.
- Slots for headphones and visor.
- Headband made of expanded polyethylene and removable and washable chinstrap.
- Security device release system (according to regulations) between 15 and 25 daN.
- Rear adjustable size system and headlamp clips.
- Casco dielettrico con isolamento fino a 1000 volt.
- Dotato di fibbia a sgancio rapido e sottogola regolabile e removibile.
- Sede per alloggiamento cuffie e visiera.
- Girotesta in polietilene espanso e sottogola removibili e lavabili.
- Sistema di sgancio di sicurezza (secondo normativa) tra 15 e 25 daN.
- Regolatore posteriore e clip fermalampada.



#	CE	Material	Color	 g	Size	cm
99711AW00KK	EN 397 EN 50365	ABS	□	390	UNI	55/63

### OPTIONAL ACCESSORIES:

- SMALL visor: Transparent #997041P01KK - Smoky #997041F01KK
- LARGE visor: Transparent #997041P00KK - Smoky #997041F00KK

### ACCESSORI OPZIONALI:

- Visiera SMALL: Trasparente #997041P01KK - Fumè #997041F01KK
- Visiera LARGE: Trasparente #997041P00KK - Fumè #997041F00KK

## VISORS

- Visor helmets with mounting kit included.
- Easily mountable thanks to the pre-marked holes in the shell.
- Visiera per casco con kit per il fissaggio incluso.
- Facilmente montabile grazie ai fori nella calotta pre-segnati.



**Fixing accessories included.**  
Kit per il fissaggio incluso.



## NET VISOR

**NEW**

- Matte black and nylon mesh Peltor® visor for good ventilation and face protection.
- Specially designed peak protects eyes from glare and reflection.
- Very lightweight and non conductive.
- Mesh Size: 1 x 1 mm.
- Visiera Peltor® con rete in nylon di color nero opaco che garantisce una buona ventilazione e protezione del viso.
- La rete è progettata per proteggere gli occhi dal riverbero e dai riflessi luminosi.
- Molto leggera e non conduttivo elettricamente.
- Dimensioni della maglia: 1 x 1 mm.



#	CE	Material	Color	g
<b>VISORS</b>				
997056F00KK	EN 166	polycarbonate	smoked	80
997056P00KK	EN 166	polycarbonate	transparent	80
997046P00KK	EN 166	polycarbonate	transparent long	125
<b>NET VISOR</b>				
997045000KK	-	nylon	■	70

## EARMUFFS



**NEW**

- Noise reduction 3M Peltor® headphones available in 3 versions with different levels of acoustic insulation.
- All models conform to UNI EN 352-1 norm.
- New version electrically insulated.
- Cuffie 3M Peltor® per abbattimento rumore disponibili in 3 versioni con diversi livelli di isolamento acustico.
- Tutta la serie è conforme alla norma UNI EN 352-1.
- Nuova versione isolata elettricamente.



#	CE	Material	Color	g	Noise Reduction
999130000KK	EN 352-1	-	■	255	32 dB
999140000KK	EN 352-1	-	■	225	30 dB
999160000XK	EN 352-1	-	■	185	26 dB
999180000KK	EN 352-1	-	■	236	32 dB
999190000KK	EN 352-1	-	■	353	36 dB
999200000KK	EN 352-1	-	■	185	26 dB
999210000KK	EN 352-1	-	■	236	32 dB

## BLUETOOTH COMMUNICATION SYSTEM

**NEW**

- Bluetooth communication system applicable in just a few seconds to any Peltor® hearing protection.
- Allows you to convert a normal hearing protection in a practical communication system that can be connected via Bluetooth to your phone, to be able to talk comfortably while maintaining a high soundproofing.
- Microphone with noise canceling system.
- Sistema di comunicazione Bluetooth applicabile in pochi secondi a qualunque cuffia antirumore Peltor®.
- Permette di convertire una normale cuffia antirumore in un pratico sistema di comunicazione collegabile via Bluetooth al vostro telefono, per poter parlare comodamente mantenendo al tempo stesso un elevato isolamento acustico.
- Microfono con sistema di cancellazione del rumore di fondo.

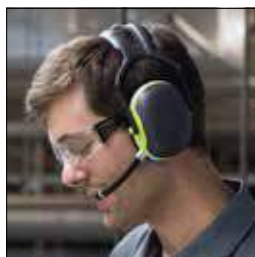

## KLIK 2

- Compact and powerful headlamp (up to 120 meter beam).
- Front bulb for depth and lateral LED for diffused light.
- 7 modes (front bulb: medium, high, low and strobe SOS - lateral LED: high, low and strobe SOS).
- IPX6 waterproof protection class.
- Lampada frontale compatta e potente (fino a 120 m di profondità del fascio luminoso).
- Lunga durata delle batterie.
- Lampadina frontale di profondità e LED laterali per luce diffusa.
- 7 modi d'uso (lampadina frontale: luce media, alta, bassa e strobo SOS - LED laterali: luce alta, bassa e strobo SOS).
- Impermeabilità: IPX6, resistente all'acqua.



## KLIK MICRO

- Ultra compact headlamp recommended in case of emergency.
- It can be attached as a signaling light on a backpack via the metal clip.
- Front bulb for depth and lateral red LED for signaling.
- 4 modes (front bulb: high and low - red LED: fixed and SOS strobe).
- IPX6 waterproof protection class.
- Lampada frontale ultracompatte consigliata per utilizzo come lampada di emergenza.
- Può essere utilizzata come luce di segnalazione fissandola sullo zaino tramite la clip a molla; l'elastico può essere rimosso.
- Lampadina frontale di profondità e LED rossi per luce di segnalazione.
- 4 modi d'uso (lampadina frontale: luce alta e bassa - LED rossi: luce fissa e strobo SOS).
- Impermeabilità: IPX6, resistente all'acqua.



#	CE	Material	Color	 g
999170000KK	-	-	<input type="checkbox"/> <input checked="" type="checkbox"/>	55

#	Output lumen	Beam depth m	Battery life h	Color	 g
<b>KLIK 2</b>					
951010B00KK	122	120	180	<input checked="" type="checkbox"/>	56
951010O00KK	122	120	180	<input checked="" type="checkbox"/>	56
951010R00KK	122	120	180	<input checked="" type="checkbox"/>	56
<b>KLIK MICRO</b>					
951011B00KK	25	25	96	<input checked="" type="checkbox"/>	24
951011O00KK	25	25	96	<input checked="" type="checkbox"/>	24

# 3

## Why choose a Kong harness?

- Constructed of the highest quality materials
- Easy to put on, comfortable to wear
- Durable
- Our harnesses can be customized with your logo and/or corporate colors
- Produced in Italy

## Perché scegliere una imbracatura Kong?

- È prodotta in Italia
- È facile e veloce da indossare, ergonomica e resistente
- È realizzata con materiali di qualità
- È prodotta con cuciture altamente resistenti
- Per quantitativi minimi idonei può essere personalizzata con loghi e colori istituzionali del cliente



Target Pro Industrial Turbo



Target Pro



Ektor



HHO Turbo



Eko



Sierra Duo



Sierra Trio



Safety Belt



Hammock



Pegasus

## TARGET PRO INDUSTRIAL TURBO

**NEW**

- Harness great for short duration rope access and positioning, situations where light weight and freedom of movement are primary characteristics.
- Fitted with two aluminum rings stitched on ventral and chest attachment points.
- Turbo version with automatic buckles on breast and leg loops for ultra-fast dressing, made of stainless steel AISI 316 to ensure maximum resistance in corrosive environments.
- Wide leg loops for great comfort during suspension.
- Ergonomic waist belt with light structure for the best fit and comfort
- Double-colored HT (high tenacity polyester webbing) for a fast visual check that the harness is on correctly.
- Wide gear loops for maximum efficiency and minimum size
- Comfortable big rear loop for easy handling of the operator during the different movements in the machine and on the ground.
- The upper part has an ergonomic cut. It is easy to put on, light, breathable, and padded for maximum comfort during use.
- Short, stitched longe for linking upper and lower parts, with attachment point in contrasting colors for maximum efficiency and absolute operational safety.
- Available Target Pro Industrial version without fast buckles.

- Imbracatura ottima per lavori su fune di breve durata e posizionamento, situazioni in cui leggerezza e libertà di movimento sono caratteristiche essenziali.
- Dotata di due anelli in alluminio cuciti sull'attacco ventrale e pettorale.
- Versione Turbo dotata di fibbie automatiche su pettorale e cosciali per una vestizione ultra-rapida, realizzate in acciaio inox AISI 316 per garantire la massima resistenza in ambienti corrosivi.
- Le imbottiture dei cosciali sono ampie per un maggiore confort durante la sospensione.
- Fascione vita con taglio ergonomico a struttura alleggerita, per la massima vestibilità e comfort.
- Fettuccia in poliestere HT (alta tenacità), bi-colore per un immediato controllo visivo della corretta vestizione e regolazione.
- Anelli porta materiale a struttura modulare per la massima efficacia ed il minimo ingombro.
- Anellone posteriore ad alto carico con colorazione evidente, di ampie dimensioni per facilitare le molteplici fasi di movimentazione alla macchina e su terreno esposto.
- Parte superiore (pettorale) con particolare taglio ergonomico, in materiale imbottito, traspirante e molto leggero, per il massimo confort di vestizione ed utilizzo.
- Longe corta di accoppiamento cucita, con anello di aggancio in colorazione evidente per la massima efficacia ed assoluta sicurezza operativa.
- Disponibile la versione Target Pro Industrial senza fibbie rapide.



Watch the video  
Guarda il video

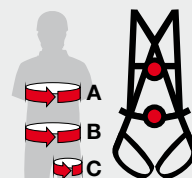

#	CE	Color	g	Size	A cm	B cm	C cm
<b>TARGET PRO INDUSTRIAL</b>							
8W9732000KK	EN 361 EN 813	■ ■	1220	S	75/85	60/95	40/60
8W9733000KK	EN 361 EN 813	■ ■	1280	M/L	86/110	75/110	50/70
8W9735000KK	EN 361 EN 813	■ ■	1330	XL	86/110	85/130	65/78
<b>TARGET PRO INDUSTRIAL TURBO</b>							
8W9632000KK	EN 361 EN 813	■ ■	1660	S	75/85	60/95	40/60
8W9633000KK	EN 361 EN 813	■ ■	1720	M/L	86/110	75/110	50/70
8W9635000KK	EN 361 EN 813	■ ■	1770	XL	86/110	85/130	65/78

## TARGET PRO

- Rescue and heli-rescue harness, great also for short duration rope access and positioning, situations where light weight and freedom of movement are primary characteristics.
- Wide, breathable and padded leg loops for maximum comfort of use.
- Ergonomic waist belt with light structure for the best fit and comfort.
- Yellow fluo finishing for the best visibility during operational phase.
- Double-colored HT (high tenacity polyester webbing ) for a fast visual check that the harness is on correctly.
- Wide gear loops for maximum efficiency and minimum size.
- Comfortable big rear loop for easy handling of the operator during the different movements in the machine and on the ground.
- The upper part has an ergonomic cut. It is easy to put on, light, breathable, and padded for maximum comfort during use.
- Automatic buckle for a fast dressing.
- Short, stitched longe for linking upper and lower parts, with attachment point in contrasting colors for maximum efficiency and absolute operational safety.
- Imbracatura da soccorso ed elisoccorso, ottima anche per lavori su fune di breve durata e posizionamento, situazioni in cui leggerezza e libertà di movimento sono caratteristiche essenziali.
- Ampie imbottiture su fasce-cosciali, in materiale traspirante per il massimo comfort in utilizzo prolungato.
- Fascione vita con taglio ergonomico a struttura alleggerita, per la massima vestibilità e comfort.
- Finiture e particolari in colore giallo fluo, per una maggiore visibilità in fase operativa.
- Fettuccia in poliestere HT (alta tenacità), bi-colore per un immediato controllo visivo della corretta vestizione e regolazione.
- Anelli porta materiale a struttura modulare per la massima efficacia ed il minimo ingombro.
- Anellone posteriore ad alto carico con colorazione evidente, di ampie dimensioni per facilitare le molteplici fasi di movimentazione alla macchina e su terreno esposto.
- Parte superiore (pettorale) con particolare taglio ergonomico, in materiale imbottito, traspirante e molto leggero, per il massimo confort di vestizione ed utilizzo.
- Fibbia RAPIDA di chiusura e posizionamento (pettorale) per un efficace ed immediato "assetto" operativo.
- Longe corta di accoppiamento cucita, con anello di aggancio in colorazione evidente per la massima efficacia ed assoluta sicurezza operativa.

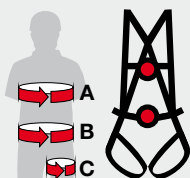

#	CE	Color	g	Size	A cm	B cm	C cm
<b>TARGET PRO</b>							
8W9932000KK	EN 361 - EN 358 EN 12277/A/C - EN 813	■ ■ ■	850	S	75/85	60/95	40/60
8W9933000KK	EN 361 - EN 358 EN 12277/A/C - EN 813	■ ■ ■	875	M/L	86/110	75/110	50/70
8W9935000KK	EN 361 - EN 358 EN 12277/A/C - EN 813	■ ■ ■	900	XL	86/110	85/130	65/78
<b>TARGET PRO TURBO</b>							
8W9832001KK	EN 361 - EN 358 EN 12277/A - EN 813	■ ■ ■	1290	S	75/85	60/95	40/60
8W9833001KK	EN 361 - EN 358 EN 12277/A - EN 813	■ ■ ■	1315	M/L	86/110	75/110	50/70
8W9835001KK	EN 361 - EN 358 EN 12277/A - EN 813	■ ■ ■	1340	XL	86/110	85/130	65/78



Fast buckles on chest and leg loops for TARGET PRO TURBO version.

Fibbie rapide su pettorale e cosciali per versione TARGET PRO TURBO.

## EKTOR

- Work harness for positioning and suspension.
- Main features:
  - Wide waist belt with high cut for maximum support of the lumbar.
  - Comfortable leg loop padding for maximum comfort during prolonged use.
  - 2 wide lateral gear loops.
  - 5 rear slots that allow you to isolate gear and fully customize your equipment layout, facilitating quick identification.
  - 4 fast buckles on waist and legs, for effective and immediate dressing.
  - Sternal and dorsal fall arrester attachment points.
  - Ventral attachment point for rope progression.
  - Lateral and foldable positioning points made of aluminum alloy, which reduce the possibility of snagging when not in use.

- Imbracatura da lavoro per posizionamento e sospensione.
- Caratteristiche principali:
  - Ampio fascione girovita con taglio alto, per il massimo sostegno della fascia lombare.
  - Comode imbottiture sui cosciali, per il massimo confort in utilizzo prolungato.
  - 2 ampi anelli porta-materiale laterali.
  - 5 asole in fettuccia per ospitare materiale isolato e permettere di personalizzare al massimo la disposizione dell'attrezzatura, facilitandone l'immediata individuazione.
  - 4 fibbie RAPIDE di chiusura su vita e cosciali, per un'efficace ed immediata vestizione.
  - Punti di attacco anticaduta sternale e dorsale.
  - Punto di attacco ventrale per la progressione su fune.
  - Punti di posizionamento laterali in alluminio ripiegabili a scatto, che riducono la possibilità d'impiglio quando non utilizzati.

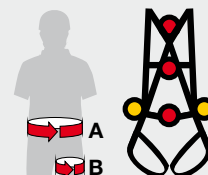

#	CE	Color	g	Size	A cm	B cm
8W9963000KK	EN 361 - EN 358 EN 813	■ ■	1950	M/L	72/105	50/68
8W9965000KK	EN 361 - EN 358 EN 813	■ ■	2050	XL	89/130	62/80



## HHO TURBO

**NEW**

- Special harness for work at height and rescue activities, fitted with a redesigned, ergonomic and breathable rear padding that makes the dressing fast and easy.
- Fast buckles on leg loops.
- Dorsal attachment point oved up, easily accessible even during the carrying of material on shoulder (oxygen cylinders, backpacks, etc.).
- Sternal attachment point with wide yellow rings for an easy identification that can be used also as handles for handling the operator.
- HT polyester webbing (High Tenacity).
- Tubular webbing.
- Fast buckle for closure and positioning (pectoral), for an effective and immediate operational attitude.
- Available "flame retardant" version.
- Imbracatura da lavoro e soccorso con una nuova, ristilizzata ed ergonomica imbottitura posteriore traspirante che facilita la vestizione.
- Fibbie rapide sui cosciali.
- Attacco dorsale spostato in alto, facilmente accessibile anche durante il trasporto a spalla di materiale (bombole d'ossigeno, zaini, ecc.).
- Punto d'attacco anteriore realizzato con due ampi anelli gialli fluo che ne facilitano l'individuazione, utilizzabili come maniglie per la movimentazione dell'operatore.
- Fettuccia in poliestere HT (Alta tenacità).
- Anelli porta-materiale in fettuccia.
- Fibbia RAPIDA di chiusura e posizionamento (pettorale), per un efficace ed immediato assetto operativo.
- Disponibile versione con trattamento "flame retardant".







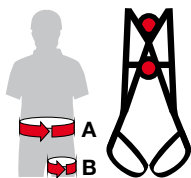

 **Fast buckles on leg loops.**

Fibbie rapide sui cosciali.

 **EASA CM n° CM-CS-005:2014**





#	€	Color	 g	Size	A cm	B cm
<b>HHO TURBO</b>						
8W9902001KK	EN 361		850	S	60/95	40/60
8W9903001KK	EN 361		900	M/L	72/105	50/62
8W9905001KK	EN 361		950	XL	89/130	62/80
<b>HHO "FLAME RETARDANT"</b>						
8W9902101KK	EN 361		850	S	60/95	40/60
8W9903101KK	EN 361		900	M/L	72/105	50/62
8W9905101KK	EN 361		950	XL	89/130	62/80

## EKO

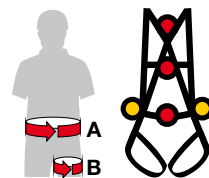
- Work harness for rope access and positioning, very appreciated by the Fire Department for the lightness and comfort.
- Eko is fitted with three anchor points (ventral, dorsal and sternal) plus the innovative side positioning rings made of textile webbing to further reduce weight.
- Wide padding ensures maximum comfort of use; lightened padded waist belt ensures great breathability.
- Ready for the installation of the ventral rope clamps mod. Futura Body # 824.01 and mod. Cam Clean # 824.
- Available in two sizes (M/L and XL).
- Imbracatura da lavoro e posizionamento, molto apprezzata dai Vigili del Fuoco per la leggerezza e la comodità.
- Dotata di tre punti di ancoraggio (ventrale, sternale e dorsale) più gli innovativi anelli di posizionamento laterali realizzati in fettuccia tessile per ridurre ulteriormente il peso.
- Ampie imbottiture che garantiscono il massimo confort di utilizzo; imbottitura della cintura girovita alleggerita per aumentare la traspirabilità.
- Predisposta per il montaggio dei bloccanti ventrali Futura Body #824.01 e Cam Clean #824.
- Disponibile in due taglie (M/L e XL).



#	€	Color	 g	Size	A cm	B cm
8W9953000KK	EN 361 - EN 358 EN 12277/A/C - EN 813		1400	M/L	72/105	50/68
8W9955000KK	EN 361 - EN 358 EN 12277/A/C - EN 813		1450	XL	89/130	62/80

## SIERRA DUO

- Fall arrest work harness, lightweight, practical and safe. Equipped with two anchor points (sternal and dorsal).
- Can be combined with positioning belt mod. Safety Belt # 8W.002
- Buckles and dorsal attachment point made in stainless steel.
- Equipped with two wide gear loops on the sides to the rear.
- Available in two sizes (M/L and XL).
- Imbracatura anticaduta da lavoro, leggera, pratica e sicura. Dotata di due punti di ancoraggio (sternale e dorsale).
- Abbinabile al cinturone di posizionamento mod. Safety Belt #8W.002
- Fibbie e attacco dorsale in acciaio. Dotata di due ampi anelli porta-materiale posti lateralmente in posizione arretrata.
- Disponibile in due taglie (M/L e XL).



## SIERRA TRIO

- Fall arrest work harness, lightweight, practical and safe. Equipped with three anchor points (sternal, ventral and dorsal).
- Buckles and dorsal attachment point made in stainless steel.
- Equipped with two wide gear loops on the sides to the rear.
- Available in two sizes (M/L and XL).
- Imbracatura da lavoro per anticaduta e posizionamento, leggera, pratica e sicura. Dotata di tre punti di ancoraggio (sternale, sternale e dorsale) più due anelli laterali per il posizionamento.
- Fibbie, attacchi laterali e attacco dorsale in acciaio. Dotata di due ampi anelli porta-materiale posti lateralmente in posizione arretrata.
- Disponibile in due taglie (M/L e XL).



Available the version conform to ANSI/ASSE Z359.11-2014.  
Disponibile in versione certificata ANSI/ASSE Z359.11-2014.

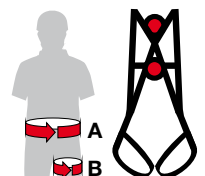
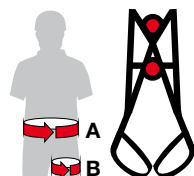

#	€	Color	g	Size	A cm	B cm
<b>SIERRA DUO</b>						
8W0323000KK	EN 361 - EN 12277/A	■ ■	850	M/L	72/105	50/62
8W0325000KK	EN 361 - EN 12277/A	■ ■	900	XL	89/130	62/80
<b>SIERRA DUO ANSI</b>						
8W0053000KK	ANSI/ASSE Z359.11-2014	■ ■	1090	M/L	72/105	50/62
8W0055000KK	ANSI/ASSE Z359.11-2014	■ ■	1130	XL	89/130	62/80

#	€	Color	g	Size	A cm	B cm
8W0603000KK	EN 361 - EN 358 EN 12277/A/C - EN 813	■ ■	1100	M/L	72/105	50/62
8W0605000KK	EN 361 - EN 358 EN 12277/A/C - EN 813	■ ■	1200	XL	89/130	62/80

## SAFETY BELT

- Safety Belt positioning harness.
- Wide and breathable paddings for maximum comfort of use.
- Ergonomic belt with light structure for the best fit and comfort.
- Steel high resistance side attachment loops.
- Fitted with two wide rear gear loops.
- Automatic buckle for a fast dressing.
- It can be used in combination with SIERRA DUO harness #8W.032.
- Cintura di posizionamento per lavoro.
- Ampie imbottiture in materiale traspirante per il massimo confort in utilizzo prolungato.
- Fascione-vita con taglio ergonomico per la massima vestibilità e confort.
- Anelli di attacco laterali in acciaio ad alta resistenza.
- Dotata di due ampi porta materiali posteriori.
- Fibbia rapida di chiusura, per un efficace ed immediato assetto operativo.
- Può essere utilizzata in abbinamento all'imbrago SIERRA DUO.



## DIAPASON

- Heavy load spacer for harnesses, designed for progression in confined spaces.
- Fitted with a rigid structure to not interfere with the head.
- Supplied with two screw sleeve connectors for attachment to the shoulder of harness.
- Distanziatore ad alto carico per imbracature da lavoro studiato per la progressione in ambienti confinati.
- Dotato di struttura rigida per non interferire con la testa.
- Fornito con due connettori a ghiera per il fissaggio agli spillacci dell'imbracatura.



#	€	Color	g	Size	A cm
<b>SAFETY BELT</b>					
8W0023000KK	EN 358	■	550	M/L	80/110
8W0025000KK	EN 358	■	600	XL	90/130
<b>DIAPASON</b>					
276SETV01KK	EN 358 - EN 354 EN 566 - EN 795/B	■ ■	500	UNI	-

## HAMMOCK

**NEW**

- Seat for prolonged suspension, characterized by an innovative design.
- The removable aluminum frame guarantees maximum lightness and reduced dimensions.
- The seat is made with a weave of tapes and fits perfectly to the body. This results in incredible ergonomics and a high level of breathability.
- When disassembled and stored in its bag, the Hammock takes up very little space.
- Perfect for use combined with the Target Pro Industrial harness.
- Sedile per sospensioni prolungate, caratterizzato da un design innovativo.
- Il telaio smontabile in alluminio garantisce la massima leggerezza e dimensioni ridotte.
- La seduta realizzata con un intreccio di fettucce, si adatta perfettamente al corpo; ne risulta un'incredibile ergonomia e un alto livello di traspirabilità.
- Una volta smontato e riposto nella sua sacca, Hammock occupa davvero pochissimo spazio.
- Perfetto per l'utilizzo combinato con l'imbracatura Target Pro Industrial.



**Removable and ergonomic.**  
Smontabile ed ergonomico.



Watch the video  
Guarda il video



#	€	Material	Color	g	Size
8W0060000KK	-	aluminum polyester	■ ■	895	UNI
8W0060N00KK	-	aluminum polyester	■	895	UNI



**Max load 200 kg!**  
Carico massimo 200 kg!



## PEGASUS

- Pegasus is the advanced KONG evacuation triangle for rescue.
- Designed for a very easy and rapid evacuation of injured person; very low weight (690g).
- Its 15 independent attachment loops make it adaptable, rapidly and safely, to all body sizes from children to adults.
- This product, max. load 200Kg, guarantees its use also for overweight people.
- Pegasus is conform to CE and EAC norms and to the requirements of the EASA Certification Memorandum CM-CS-005.
- The rear handle can be used to connect a guide rope or to insert in the cabin the retrieved person.
- The supplementary shoulder straps (# 873100000KK) allow the use of Pegasus in narrows and difficult places (ladders, tunnels, etc).
- Universal size, made in Italy of strong Nylon.
- Conform to CE EN 1498/B.
- New carriage bag, ergonomic, compact and equipped with attachment point for harness or helicopter winch.
- Pegasus è il triangolo di evacuazione KONG per il soccorso.
- Progettato per ridurre al minimo i tempi d'intervento e dal peso molto contenuto (690g).
- Grazie ai suoi 15 punti di attacco può essere utilizzato sia per adulti che per bambini e permette di essere indossato in modo rapido e sicuro.
- Il prodotto, con un carico massimo di 200Kg, garantisce il possibile utilizzo anche per persone di peso molto elevato.
- Pegasus è certificato CE, EAC ed è in accordo con i requisiti dell'EASA Certification Memorandum CM-CS-005.
- La maniglia posteriore può essere utilizzata per la connessione di un cordino guida o per l'inserimento in cabina della persona recuperata.
- Le bretelle accessorie (# 873100000KK) permettono di evacuare a spalla i feriti da luoghi particolarmente stretti (scale, cunicoli, etc).
- Taglia universale, realizzato in Italia in resistente Nylon.
- Certificato CE EN 1498/B.
- Nuova borsa per il trasporto, ergonomica, compatta e dotata di punto di aggancio per imbracatura o verricello.



**New bag included!**  
Nuova sacca inclusa!

#	CE	Material	Color	g	Size
873000000KK	EN 1498/B	cordura nylon		580	UNI



Historic building inspection (Cremona - Italy) - ph: Michele Comi

## Why choose Kong gloves?

- They are manufactured with high quality materials - Kevlar, natural leather, breathable Nylon
- Wide range of models
- Ergonomically designed for a comfortable fit
- They are resistant to wear
- Sizes range from XS to XXL for closest fit to any sized hand

## Perché scegliere guanti Kong?

- Perché c'è una vasta gamma di modelli
- Sono prodotti con materiali di qualità (Kevlar rinforzato, pelle naturale, Nylon traspirante...)
- Sono comodi ed ergonomici
- Sono resistenti all'usura
- Il numero di taglie copre tutte le misure di tutte le dimensioni delle mani

## PRO GLOVES

**NEW**

- Strong leather gloves conceived for belay and double rope use, they combine the strength of a work glove with the precision and sensitivity of a thin glove.
- Excellent also for use in work and rescue situations.
- The double-layered leather protects the most exposed parts of the hand.
- Elastic wrist with Velcro closure.
- Made of smooth and soft leather for a perfect balance between strength and sensitivity.
- Guanti resistenti in pelle per assicurazione e doppie che combinano la robustezza di un guanto da lavoro con la precisione e la sensibilità di un guanto sottile.
- Ottimi anche per l'utilizzo in situazioni di lavoro e soccorso.
- La pelle doppio strato protegge le parti più esposte della mano.
- Polso elastico con chiusura in Velcro.
- Fabbricato in pelle di alta qualità per un perfetto equilibrio tra robustezza e sensibilità.



## PRO AIR GLOVES

**NEW**

- Smoother and lighter version with full elastic back, made with breathable nylon, abrasion-resistant that ensures optimum wearability and comfort.
- Reinforced palm with extra suede layer.
- Versione più soffice e leggera con dorso completamente in nylon elastico traspirante, resistente all'abrasione, che garantisce comfort e ottima vestibilità.
- Palmo rinforzato con uno strato di pelle scamosciata.



#	CE	Material	Color	g	Size
<b>PRO GLOVES</b>					
95207NNN3KK	EN 388	leather/nylon	■	135	M
95207NNN4KK	EN 388	leather/nylon	■	145	L
95207NNN5KK	EN 388	leather/nylon	■	155	XL
<b>PRO AIR GLOVES</b>					
95208NNN3KK	EN 388	leather/suede/nylon	■	115	M
95208NNN4KK	EN 388	leather/suede/nylon	■	125	L
95208NNN5KK	EN 388	leather/suede/nylon	■	135	XL

## SKIN GLOVES

- Lightweight gloves conceived for belay and double rope use, that combine the strength of a work glove with the precision and the sensitivity of a thin glove.
- Excellent also for the use in work and rescue situations.
- The double-layered skin protects the most exposed parts of the hand.
- The elastic back, made with breathable nylon, resists abrasion and ensures optimum wearability and comfort.
- Elastic wrist with Velcro closure.
- Made of smooth and soft leather for a perfect balance between strength and sensitivity.
- Reinforced thumb and index with special rubber for durability during the rope handling.
- Available in 4 sizes from S to XL.
- Certified CE EN 388 (4-2-4-3).
- Guanti leggeri per assicurazione e doppie che combinano la robustezza di un guanto da lavoro con la precisione e la sensibilità di un guanto sottile.
- Ottimi anche per l'utilizzo in situazioni di lavoro e soccorso.
- La pelle doppio strato protegge le parti più esposte della mano.
- Il dorso in nylon elastico traspirante resiste all'abrasione e garantisce comfort e ottima vestibilità.
- Polso elastico con chiusura in Velcro.
- Fabbricato in pelle naturale «alta qualità» per un perfetto equilibrio tra robustezza e sensibilità.
- Polpastrello di pollice e indice rinforzato in gomma speciale per la massima resistenza durante la gestione della corda.
- Disponibile in 4 taglie, dalla S alla XL.
- Certificati CE EN 388 (4-2-4-3).



#	CE	Material	Color	g	Size
95205N002KK	EN 388	suede/nylon/rubber	■	75	S
95205N004KK	EN 388	suede/nylon/rubber	■	80	M
95205N006KK	EN 388	suede/nylon/rubber	■	85	L
95205N007KK	EN 388	suede/nylon/rubber	■	90	XL

## FULL GLOVES

- High quality leather gloves with Kevlar reinforcement on palm and fingers, the perfect choice for via ferrata, adventure parks and rescue.
- Elastic wrist with Velcro closure ensures a great fit.
- The elastic back, made with breathable nylon, resists abrasion and ensures the best wearability and confort.
- Available in 5 sizes (S, M, L, XL, XXL).
- Certified CE EN 388 (4-2-4-3) and CE EN 420.
- Available Aero version with reinforced right palm.
- Guanti di alta qualità realizzati in pelle con rinforzo in Kevlar su palmo e dita, ideali per vie ferrate, parchi avventura, soccorso.
- Polso elastico con chiusura in Velcro che garantisce un'ottima vestibilità.
- Dorso in Nylon elasticizzato traspirante e resistente all'abrasione.
- Disponibili in 5 taglie (S, M, L, XL, XXL).
- Certificati CE EN 388 (4-2-4-3) e CE EN 420.
- Disponibile in versione Aero con palmo destro rinforzato.



#	CE	Material	Color	g	Size
95203YWF2KK	EN 388 EN 420	kevlar reinforced suede	■ ■ ■	105	S
95203YWF4KK	EN 388 EN 420	kevlar reinforced suede	■ ■ ■	110	M
95203YWF6KK	EN 388 EN 420	kevlar reinforced suede	■ ■ ■	115	L
95203YWF7KK	EN 388 EN 420	kevlar reinforced suede	■ ■ ■	120	XL
95203YWF8KK	EN 388 EN 420	kevlar reinforced suede	■ ■ ■	125	XXL
95203NNN3KK	EN 388 EN 420	kevlar reinforced suede	■	105	S
95203NNN4KK	EN 388 EN 420	kevlar reinforced suede	■	110	M
95203NNN6KK	EN 388 EN 420	kevlar reinforced suede	■	115	L
95203NNN7KK	EN 388 EN 420	kevlar reinforced suede	■	120	XL
95203NNN8KK	EN 388 EN 420	kevlar reinforced suede	■	125	XXL

## ALEX GLOVES

- High quality leather gloves with Kevlar reinforcement on palm and fingers, the perfect choice for via ferrata, adventure parks and rescue.
- With 3 fingers cut to 3/4.
- Elastic wrist with Velcro closure ensures a great fit.
- The elastic back, made with breathable nylon, resists abrasion and ensures the best wearability and confort.
- Available in 6 sizes (S, M, L, XL, XXL, XXXL).
- Certified CE EN 388 (4-2-4-3) and CE EN 420.
- Guanti di alta qualità realizzati in pelle con rinforzo in Kevlar su palmo e dita, ideali per vie ferrate, parchi avventura, soccorso.
- Con 3 dita tagliate a 3/4.
- Polso elastico con chiusura in Velcro che garantisce un'ottima vestibilità.
- Dorso in Nylon elasticizzato traspirante e resistente all'abrasione.
- Disponibili in 6 taglie (S, M, L, XL, XXL, XXXL).
- Certificati CE EN 388 (4-2-4-3) e CE EN 420.



#	CE	Material	Color	g	Size
95201YWF2KK	EN 388 EN 420	kevlar reinforced suede	■ ■ ■	60	S
95201YWF4KK	EN 388 EN 420	kevlar reinforced suede	■ ■ ■	63	M
95201YWF6KK	EN 388 EN 420	kevlar reinforced suede	■ ■ ■	68	L
95201YWF7KK	EN 388 EN 420	kevlar reinforced suede	■ ■ ■	72	XL
95201YWF8KK	EN 388 EN 420	kevlar reinforced suede	■ ■ ■	75	XXL
95201YWF9KK	EN 388 EN 420	kevlar reinforced suede	■ ■ ■	80	XXXL

DuPont™ and Kevlar® are trademarks or registered trademarks of E.I. du Pont de Nemours and Company.

# 5

## What is a fall arrest device?

A fall arrest device is used to protect a climber in the event of a fall. It works by limiting the distance the climber can fall reducing the amount of energy transferred to the body of the climber as the result of the arrest. Adding an energy absorber between the climber and the fall arrest device further reduces the amount of energy transferred to the body of the climber. The energy absorber “consumes” the energy generated during the fall. Kong has a wide range of fall protection equipment adaptable to any requirement of the operator, from the guided type, to lanyards with built in energy absorbers, to the classics with retractable wires or tapes.

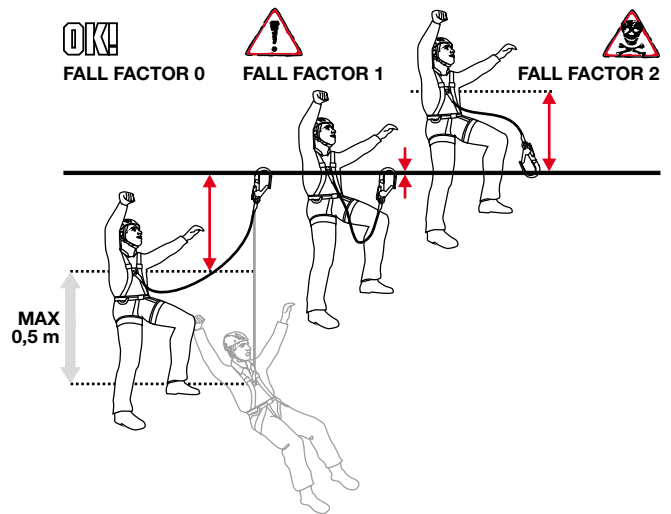

## What is a positioning device?

The positioning device has the purpose of locating the climber in space, allowing him to have both hands free for operational purposes. Positioning devices are composed of a static rope or cut-resistant metal cable, with slots for the insertion of connectors, and are available with or without a regulation system for adjusting the length. They are classified as fall protection because they “hold” the climber in place, but must not be used to arrest a fall, even minimal.

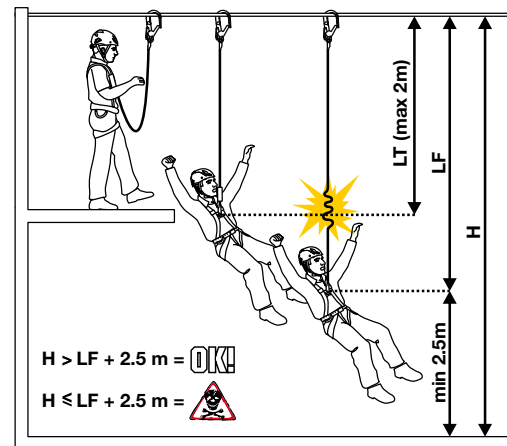

## Cos'è un dispositivo anticaduta?

I dispositivi anticaduta permettono di trattenero l'utilizzatore o arrestare la sua eventuale caduta.

I dispositivi anticaduta che “trattengono” sono normalmente cordini o fettucce con apposita certificazione. I dispositivi anticaduta finalizzati ad arrestare la caduta devono essere dotati di un dissipatore di energia che ha la funzione di “consumare” l'energia generata durante la caduta. I dissipatori, chiamati spesso “assorbitori” erroneamente in quanto non assorbono energia per poi rilasciarla ma la dissipano come l'ABS delle automobili, sono dispositivi importantissimi il cui funzionamento è purtroppo poco conosciuto. Kong dispone di un'ampia gamma di dispositivi anticaduta adattabili a qualunque esigenza dell'operatore, da quelli di tipo guidato a quelli tessili con dissipatore di energia ai classici retrattili con cavo metallico o fettuccia.

## Cos'è un dispositivo di posizionamento?

I dispositivi di posizionamento hanno la finalità di trattenero l'operatore consentendogli di liberare le mani a fini operativi. Essenzialmente sono composti da una corda statica o da cavo metallico antitaglio, dotati di asole per l'inserimento di connettori; disponibili nelle versioni con e senza regolatore per l'aggiustamento della lunghezza. Rientrano nei dispositivi anticaduta perché “trattengono”, ma non devono assolutamente essere usati per arrestare una caduta, anche minima.



# FALL ARRESTERS & POSITIONING ANTICADUTA E POSIZIONAMENTO

# 5



Back-Up



Energy  
Absorber



Retractable  
Fall Arrester



Trimmer



Wire Steel Rope



Static Rope  
Lanyard



Dynamic Rope  
Lanyard - Trilonge

## BACK-UP

- Safe and simple to use with only one hand! BACK-UP is the revolutionary KONG fall arrester that follows the operator in both directions. With the button in "lock" mode, it can also be used as a positioning device or a normal locking device. Due to its special manufacture, BACK-UP arrests the strongest falls in a semi-dynamic way that avoids the shocking effects that traditional self-locking devices with toothed cams can have on the rope. It also works with NO-CUT LANYARD Ø 12 if used according to EN 567 and UIAA 104.
- Connector included.
- Available the new ANSI version.
- Sicuro e semplicissimo da manovrare con una sola mano! BACKUP è l'innovativo anti caduta KONG che segue discretamente l'operatore sia in salita che in discesa arrestando eventuali cadute. Agendo sull'apposito pulsante può essere utilizzato anche come posizionatore o normale bloccante in quanto l'attrezzo scorre solo verso l'alto. Grazie alla sua costruzione, BACK-UP sopporta anche sollecitazioni consistenti in maniera semi-dinamica, scongiurando così gli effetti traumatizzanti recati alle corde dai tradizionali autobloccanti a camme dentate. Funziona anche con NO-CUT LANYARD Ø 12 se utilizzato in accordo alle norme EN 567 e UIAA 104.
- Connettore incluso.
- Disponibile nella nuova versione certificata ANSI.

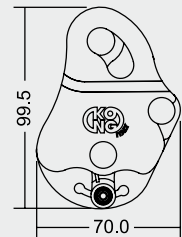
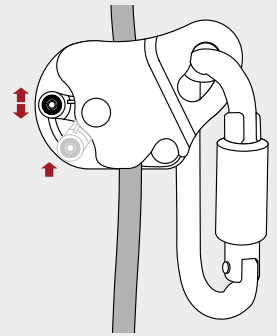
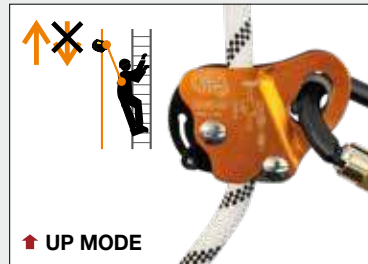
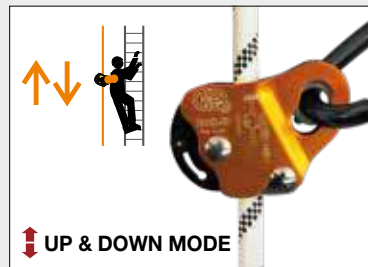

NEW



ANSI VERSION  
Z359.15-2014



Watch the video  
Guarda il video

## BACK-UP MAGNET

# 802300000KK

- Device that allows the Back-Up to work in optimal position while keeping the fall factor always lower than "1".
- Dispositivo che consente al Back-Up di lavorare in posizione ottimale mantenendo il fattore di un eventuale caduta sempre inferiore ad "1".



#	CE	Material	Color	g*	Ø mm	Connector
8020NO400KK	EN 353-2 - EN 358 EN 567 EN 12841 A/B	stainless steel alu alloy	■ ■	420	10/12	Ovalone TW
8020NO402KK	EN 353-2 - EN 358 EN 567 EN 12841 A/B	stainless steel alu alloy	■ ■	420	10/12	Ovalone AB
8021NO400KK	ANSI/ISEA Z359.15-2014	stainless steel alu alloy	■ ■	435	10/12	Ovalone TW ANSI
8021NO402KK	ANSI/ISEA Z359.15-2014	stainless steel alu alloy	■ ■	435	10/12	Ovalone AB ANSI
8021NO403KK	ANSI/ISEA Z359.15-2014	stainless steel alu alloy	■ ■	435	10/12	Ovalone DNA TW ANSI
8021NO404KK	ANSI/ISEA Z359.15-2014	stainless steel alu alloy	■ ■	435	10/12	Ovalone DNA AB ANSI

\* Connector included / Connettore incluso

## EAW BASE

- Energy absorbers reduce the impact force and the risk of injuries to the operator. The webbing tears to absorb energy in the event of a fall.
- Mesh pouch with velcro closure protects the energy absorber from abrasion and facilitates regular inspection.
- Il dissipatore d'energia riduce la forza d'impatto in caso di caduta e il rischio di infortuni dell'operatore. L'energia della caduta viene dissipata dalla lacerazione della cucitura della fettuccia.
- Custodia in tessuto con chiusura in velcro per proteggere il dissipatore di energia dall'abrasione, facilitandone il controllo periodico.



#	CE	Color	g
203030Y00KK	EN 355	Yellow	175
203030O00KK	EN 355	Orange	175

## EAW I

- 30mm elastic polyamide lanyard and energy absorber with wear indicator. The energy absorber reduces impact force and the risk of injuries to the operator by tearing in the event of a fall.
- Mesh pouch with velcro closure protects the energy absorber from abrasion and facilitates regular inspection.
- Single elastic sling version without connectors included.
- Cordino realizzato in fettuccia elastica in poliammide 30mm, dotato di dissipatore di energia ispezionabile con indicatore di usura. Il dissipatore riduce la forza di impatto in caso di caduta e il rischio di infortuni dell'operatore. L'energia della caduta viene dissipata per lacerazione di una speciale cucitura.
- Custodia in tessuto con chiusura in velcro per proteggere il dissipatore di energia dall'abrasione, consentendo il controllo periodico.
- Versione senza connettore con un solo braccio.



## EAW I SET QUEEDY

- With QUEEDY connector.
- Con connettore QUEEDY.



## EAW I SET TANGO

- With TANGO connector.
- Con connettore TANGO.



#	CE	↔ cm*	Color	g	?
<b>EAW I</b>					
201E090O0KK	EN 355	90	Orange	235	-
201E090Y0KK	EN 355	90	Yellow	235	-
201E150R0KK	EN 355	150	Red	285	-
<b>EAW I SET QUEEDY</b>					
201SETE09KK	EN 355	90	Orange	685	Queedy 24
201SETE02KK	EN 355	150	Red	735	Queedy 24
<b>EAW I SET TANGO</b>					
201SETE05KK	EN 355	150	Red	410	Tango Black

## EAW Y

- Energy absorber with elastic sling in polyamide 30mm width with elastic lanyard. The energy absorber reduce the impact force and the risk of injuries for the operator. The energy of the fall is absorbed by the tearing of specific webbing.
- Mesh pouch with velcro protects the energy absorber from abrasion and allows regular verification of the absorber's condition with stress indicator.
- Double elastic sling version without connectors.
- Cordino realizzato con 2 fettucce elastiche in poliammide 30mm, dotato di dissipatore di energia ispezionabile con indicatore di usura. Il dissipatore riduce la forza di impatto in caso di caduta e il rischio di infortuni dell'operatore. L'energia della caduta viene dissipata per lacerazione di una cucitura speciale.
- Custodia in tessuto con chiusura in velcro per proteggere il dissipatore di energia dall'abrasione, consentendo il controllo periodico.
- Versione senza connettori con due bracci.



## EAW Y SET QUEEDY

- With two QUEEDY connectors.
- Con due connettori QUEEDY.



## EAW Y SET TANGO

- With two TANGO connectors.
- Con due connettori TANGO.



#	CE	↔ cm*	Color	g	?
<b>EAW Y</b>					
202E090O0KK	EN 355	90	Orange	315	-
202E090Y0KK	EN 355	90	Yellow	315	-
202E150R0KK	EN 355	150	Red	405	-
<b>EAW Y SET QUEEDY</b>					
202SETE12KK	EN 355	90	Orange	1215	Queedy 24
202SETE13KK	EN 355	90	Orange	2195	Queedy 35
202SETE02KK	EN 355	150	Red	1305	Queedy 24
<b>EAW Y SET TANGO</b>					
202SETE15KK	EN 355	90	Orange	575	Tango Black
202SETE07KK	EN 355	150	Red	655	Tango Black

\*Max extension of elastic lanyard + energy absorber, without connectors. / Estensione massima della longe elastica + dissipatore, connettori esclusi.

## METAL CABLE CAVO METALLICO

- Retractable fall arrester with automatic recall allowing the operator a high freedom of movement while working on roofs, inclined planes, scaffolds, metal structures and tubular structures. Featuring ultra-durable ABS shell, wire rope with thimble and double gate connector with anti-twisting swivel.
- 10 m version both for horizontal and vertical use; other versions only for vertical use.
- Anticaduta retrattile a richiamo automatico, permette all'operatore un'elevata libertà di movimento durante il lavoro su tetti, piani inclinati, ponteggi, tralicci e strutture tubolari. Dotato di guscio ultra-resistente in ABS, cavo metallico asolato con redancia e connettore a doppia leva di sicurezza con girello anti-attorcigliamento.
- Versione da 10 m per utilizzo sia orizzontale che verticale; altre versioni solo per utilizzo verticale.



## WEBBING 2,5 METERS FETTUCCIA 2,5 METRI

- Retractable fall arrester with automatic recall for vertical use, fitted with 47mm nylon webbing, length 2,5m.
- Built-in energy absorber for shock absorption in case of falling.
- Anticaduta retrattile a richiamo automatico per utilizzo in verticale, con fettuccia in nylon da 47mm, lunghezza 2,5m.
- Assorbitore di energia incorporato per attutire gli urti in caso di caduta.



**For vertical use.**  
Per utilizzo verticale.

#	CE	Material	Color	↔ m	⬆ kg	∞ Ø mm
225020100KK	EN 360	zinc plated steel ABS	■	10	4,6	4,5
225010150KK	EN 360 ATEX II 2 G c T6	zinc plated steel ABS	■	15	7,2	4,5
225010200KK	EN 360 ATEX II 2 G c T6	zinc plated steel ABS	■	20	7,7	4,5

#	CE	Material	Color	↔ m	⬆ kg	∞ Ø mm
225020025KK	EN 360	nylon	■	2,5	0,9	-

## WEBBING 2 METERS FETTUCCIA 2 METRI

**NEW**

- Retractable fall arrester with automatic recall for both horizontal and vertical use and with fall factor 2.
- Polyester sling: width 21 mm, length 2 m
- External energy absorber with protective covering that can be opened for inspections.
- Rotating anchor point at the top.
- Twist-lock connector equipped with anti-twisting swivel.
- Anticaduta retrattile a richiamo automatico per utilizzo sia orizzontale che verticale e con fattore di caduta 2.
- Fettuccia in poliestere larghezza 21 mm, lunghezza 2 m
- Assorbitore di energia esterno con copertura protettiva apribile per ispezioni.
- Punto di ancoraggio superiore girevole.
- Connettore twist-lock dotato di girello anti-attorcigliamento.



 **For horizontal and vertical use.**  
**Fall factor 2.**  
Per utilizzo orizzontale e verticale.  
Fattore di caduta 2.

#	CE	Material	Color	↔ m	⚖ kg	∞ Ø mm
225020020KK	EN 360	polyester	■	2	0,9	-

## WEBBING 6 METERS FETTUCCIA 6 METRI

**NEW**

- Retractable fall arrester with automatic recall for both horizontal and vertical use.
- Polyester sling: width 21 mm, length 6 m
- External energy absorber with protective covering that can be opened for inspections.
- Rotating anchor point at the top.
- Twist-lock connector equipped with anti-twisting swivel.
- Anticaduta retrattile a richiamo automatico per utilizzo sia orizzontale che verticale.
- Fettuccia in poliestere larghezza 21 mm, lunghezza 6 m
- Assorbitore di energia esterno con copertura protettiva apribile per ispezioni.
- Punto di ancoraggio superiore girevole.
- Connettore twist-lock dotato di girello anti-attorcigliamento.



 **For horizontal and vertical use.**  
Per utilizzo orizzontale e verticale.

#	CE	Material	Color	↔ m	⚖ kg	∞ Ø mm
225020060KK	EN 360	polyester	■	6	2,4	-

## Customize your lanyard Personalizza la tua longe

- Being manufacturers allows us to work with great flexibility, studying and producing customized solutions for our customers. Here you will find an example of what we can do for a positioning lanyard package.
- Thanks to our ability to combine the various types of rope including the length, the color, the connectors stitched at the ends etc ..., the combinations are virtually endless.
- Choose the model that best meets your needs and customize it as you like by following the formula in the code legend for each product.
- Kong does not only sell products, we build up projects with our partners. Since 1830, high-quality products made in Italy!
- Essere produttori ci permette di lavorare con grande flessibilità, studiando e producendo soluzioni personalizzate per i nostri clienti. Qui trovate un esempio di ciò che possiamo fare per il confezionamento dei nostri cordini di posizionamento.
- Grazie alla possibilità di combinare le varie tipologie di corda, la lunghezza, il colore, i connettori cuciti alle estremità, ecc..., le combinazioni sono praticamente infinite.
- Scegliete il modello che più soddisfa le vostre esigenze e personalizzatelo come volete seguendo le logiche dei codici spiegate nei box.
- Kong non vende solo prodotti ma costruisce progetti con i propri partner. Dal 1830 prodotti di alta qualità fatti in Italia!

## WIRE STEEL ROPE

- Positioning and anchoring no-cut lanyard with two loops. Galvanized steel cable core (133 threads) Ø 6mm, double polyester sheath Ø 12mm. The innovative double sheath technology avoids sheath slippage over the cable surface.
- Cordini di posizionamento e ancoraggio di lunghezza fissa costruito con cavo d'acciaio zincato antitaglio diametro 6 mm (133 fili) ricoperto da doppia calza in poliestere con diametro esterno di 12 mm. L'innovativa costruzione a doppia calza evita che questa possa scorrere sulla superficie del cavo.

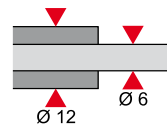

**No cut!**  
Antitaglio!

**Metal cable core (133 threads) Ø 6 mm. Poliestere sheath Ø 12 mm.**  
Anima in cavo d'acciaio (133 fili) Ø 6 mm. Calza in poliestere Ø 12 mm.

### NO-CUT LANYARD WITH TWO LOOPS LONGE ANTITAGLIO CON DUE ASOLE

#	CE	Color	◀ kN	↔ m	⬆ g	∞ Ø mm
277M00100KK	EN 354 - EN 358 - EN 795	■ ■	25	1	295	12
277M00120KK	EN 354 - EN 358 - EN 795	■ ■	25	1,2	345	12
277M00160KK	EN 354 - EN 358 - EN 795	■ ■	25	1,6	440	12
277M00200KK	EN 354 - EN 358 - EN 795	■ ■	25	2	540	12
277M00300KK	EN 354 - EN 358 - EN 795	■ ■	25	3	780	12
277M00500KK	EN 354 - EN 358 - EN 795	■ ■	25	5	1260	12

### NO-CUT ADJUSTABLE LANYARD LONGE ANTITAGLIO CON REGOLATORE

#	CE	Color	◀ kN	↔ m	⬆ g	∞ Ø mm
277V00200KK	EN 358	■ ■	-	2	760	12
277V00300KK	EN 358	■ ■	-	3	1000	12
277V00500KK	EN 358	■ ■	-	5	1480	12

**Other size on request**  
Altre misure disponibili su richiesta

### CODE LEGEND / LEGENDA DEI CODICI

277M 0010 0 KK

0010 = 1 m  
0016 = 1,6 m  
0100 = 10 m  
...

0 - white  
R - red (on request)  
B - blue (on request)  
N - black (on request)

## STATIC ROPE LANYARD

- Semi-static lanyard with two loops 10 or 11 mm diameter for positioning and anchoring.
- Longe semi-statica con due asole diametro 10 o 11 mm per posizionamento e ancoraggio.

Protection included for sizes from 1 to 5 m

Protezione inclusa nelle misure da 1 a 5 m



Terminal loops with rubber protections!  
Terminali con protezioni in gomma!

standard color / colore standard

black on request / nero su richiesta

red on request / rosso su richiesta

blue on request / blu su richiesta

#	CE	Color	kN	m	g	Ø mm
278L00060KK	EN 354 - EN 358 - EN 566 - EN 795		25	0,6	105	11
278L00100KK	EN 354 - EN 358 - EN 566 - EN 795		25	1	135	11
278L00150KK	EN 354 - EN 358 - EN 566 - EN 795		25	1,5	172	11
278L00200KK	EN 354 - EN 358 - EN 566 - EN 795		25	2	210	11
278L00250KK	EN 354 - EN 358 - EN 566 - EN 795		25	2,5	248	11
278L00500KK	EN 354 - EN 358 - EN 566 - EN 795		25	5	440	11
278L01000KK	EN 354 - EN 358 - EN 566 - EN 795		25	10	820	11
278L01500KK	EN 354 - EN 358 - EN 566 - EN 795		25	15	1200	11
278L02000KK	EN 354 - EN 358 - EN 566 - EN 795		25	20	1580	11
278L02500KK	EN 354 - EN 358 - EN 566 - EN 795		25	25	1960	11

Other size on request  
Altre misure disponibili su richiesta

### CODE LEGEND / LEGENDA DEI CODICI

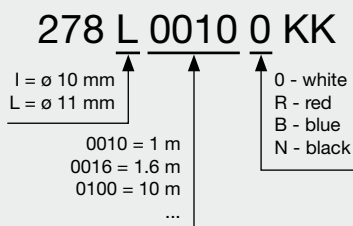

On request it is possible to assemble any KONG connector  
A richiesta è possibile il montaggio di qualunque connettore KONG



# 700.200 - Frog cable



# 438.YZ - Harness



# 716 - Queedy

## DYNAMIC ROPE LANYARD TRILONGE

- Positioning lanyard made of dynamic rope EN 892, 10mm diameter, with sewn eyelets and rubber terminations.
- Trilonge is the factory version conforming to EN 566:06, EN 354:10, EN 358:99, EN 795/B:12 norms, of a popular, up to date tool handcrafted by the end user.
- Features:
  - sewn eyelets with a contrasting color indicator to immediately show wear
  - rope sheath is very abrasion-resistant for use in particularly aggressive environments
  - rubber terminals are integrated into the sewn eyelets for correct and stable connector positioning
- Cordino di posizionamento realizzato in corda dinamica EN892 diametro 10mm, con asole cucite e terminali in gomma.
- La Trilonge è la versione "di fabbrica" e certificata EN 566:06, EN 354:10, EN 358:99, EN 795/B:12 di uno strumento molto diffuso ma fino ad oggi realizzato artigianalmente dall'utilizzatore finale.
- Caratteristiche:
  - cucitura delle terminazioni con spia in colore a contrasto per immediata verifica dell'usura
  - calza della corda molto resistente alle abrasioni per un utilizzo in ambienti particolarmente aggressivi
  - terminali in gomma integrati per il posizionamento corretto e stabile dei connettori alle terminazioni cucite

NEW! Dynamic lanyard  
NOVITÀ! Longe dinamica



#	CE	Color	kN	m	g	Ø mm
279I00301KK	EN 354 - EN 358 - EN 566 - EN 795/B		22	3	280	10

## TRIMMER

The TRIMMER adjustable lanyard is for use in work positioning systems, in conjunction with a fall arrest device. It enables quick and accurate length adjustment, allowing optimal work station positioning.

Main features:

- Fitted with a device for progressive length adjustment for the optimal work position.
- It can be used on the harness lateral attachment points to distribute the load of an upright user: the length is adjusted by pressing the ergonomic lever.
- You can use the single ventral attachment point of the harness to distribute the load between the belt and the leg loops of the suspended user.
- Fitted with a sliding protective sheath to protect the rope from contact points that could damage it.
- Lightweight and compact.
- Available in four lengths: 2, 3, 4 and 5 m.
- Other lengths available on request.
- The longer lengths (more than 5 m) come with black-colored rope for easy set identification.

TRIMMER è utilizzato per realizzare sistemi di posizionamento sul lavoro in abbinamento ad un dispositivo anticaduta. Consente la regolazione rapida e precisa della lunghezza necessaria in base alle condizioni del posto di lavoro per un posizionamento ideale.

Caratteristiche principali:

- Dotato di dispositivo per la regolazione progressiva della lunghezza ideale per la migliore posizione di lavoro.
- Si utilizza sui punti di attacco laterali dell'imbracatura per ripartire il carico dell'utilizzatore in appoggio sui piedi: la regolazione avviene premendo la comoda leva.
- Si può utilizzare sul punto di attacco ventrale dell'imbracatura per ripartire il carico tra la cintura ed i cosciali dell'utilizzatore in sospensione.
- Dotato di guaina di protezione per proteggere la corda dai punti di contatto che potrebbero danneggiarla favorendone lo scorrimento.
- Peso e dimensioni ridotte.
- Disponibile in quattro lunghezze: 2, 3, 4 e 5 m.
- Altre lunghezze disponibili su richiesta.
- Colorazione nera per misure superiori ai 5 m per facilitare la distinzione dei set.



Watch the video  
Guarda il video



**NEW**

# 802080000KK

- Trimmer device available without inserted rope.
- Dispositivo Trimmer senza corda inserita.



#	CE	Color	↔ m	⚖ g	∅ mm	🔗
<b>TRIMMER</b>						
289U00200KK	EN 358	■ ■	2	375	11	-
289U00300KK	EN 358	■ ■	3	455	11	-
289U00400KK	EN 358	■ ■	4	535	11	-
289U00500KK	EN 358	■ ■	5	615	11	-
<b>TRIMMER SET</b>						
289SETU01KK	EN 358	■ ■	2	510	11	Tango
289SETU02KK	EN 358	■ ■	3	590	11	Tango
289SETU03KK	EN 358	■ ■	4	670	11	Tango
289SETU04KK	EN 358	■ ■	5	750	11	Tango
289SETU21KK	EN 358	■ ■	2	915	11	Queedy 24
289SETU22KK	EN 358	■ ■	3	915	11	Queedy 24

**!** Other sizes and connectors on request  
Altre misure e altri connettori su richiesta

**CODE LEGEND / LEGENDA DEI CODICI**

289U 0020 0 KK

0020 = 2 m  
0025 = 2.5 m  
0100 = 10 m  
...

0 - white  
N - black  
R - red (on request)  
B - blue (on request)



# 6

## What are anchor devices?

An anchor device is “the first link in the chain”. The choice of anchor point is one of the most delicate phases during work at height, as the safety of the whole system depends on them. These points should always be chosen by qualified personnel. The range of “anchor devices” is very wide and includes many types: fixed anchors, mobile anchors, textiles, metal, rigging plates, lifelines, tripods, bipods... Kong offers a wide range of anchor devices to satisfy all the different needs.

## Cosa sono gli ancoraggi?

Il punto di ancoraggio è “il primo anello della catena”. La scelta del punto di ancoraggio è una delle fasi più delicate durante i lavori in quota, in quanto da essa dipende la tenuta di tutto il sistema. Tale fase deve sempre essere eseguita da personale competente. Il termine “ancoraggio” è molto vasto e comprende molte tipologie: ancoraggi fissi, mobili, tessili, metallici, moltiplicatori di ancoraggi, linee vita temporanee, tripodi, bipedi... Kong offre un’ampia gamma di dispositivi di ancoraggio per assolvere alle diverse esigenze.



Aro Bull  
Lanyard Bull



Tree Fork



Wide Eye



Dancer



Ana



3Rig  
4Rig



Full



Rally  
Rally Bent



Temporary Lifeline

## BULL

- Heavy load double-layer textile anchor sling. It is produced in different lengths and is perfect for high resistance anchoring. It is made in different colors based on the length. The wear indicator facilitates product inspection. The different internal coloring also allows for immediate inspection, showing the product condition at a glance. In addition to the standard dimensions, lengths can be customized on request. All sizes are available in black.
- Ancoraggio tessile ad anello alto carico. Prodotto in differenti lunghezze è il prodotto ideale per un ancoraggio sicuro e garantito. Realizzato in diverse colorazioni in base alla lunghezza le Aro Bull e Lanyard Bull Kong permettono una verifica immediata dello stato di usura o danneggiamento. Attraverso una colorazione interna differente permettono un'ispezione immediata ed evidenziano a colpo d'occhio l'usura del prodotto. Oltre alle dimensioni standard è possibile, su richiesta, chiedere lunghezze personalizzate. Tutte le misure sono disponibili in colorazione nera.

## ARO BULL

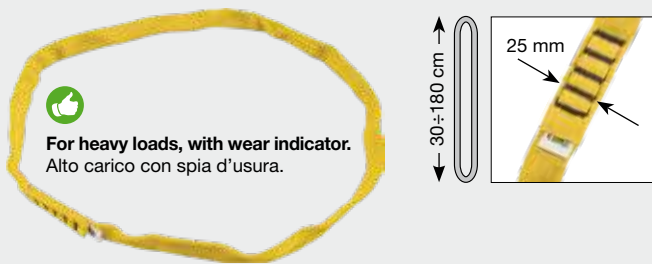

## TREE FORK

- The Tree fork is for tree climbing and is composed of heavy-load webbing and two different-sized aluminum rings, for recovery from the ground.
- Available in 3 lengths (90, 140 and 230 cm) with different colors (respectively yellow, black and red).
- In addition to the standard dimensions, it is possible on request, to produce custom lengths.
- Falsa forcella per il lavoro su alberi composta da fettuccia ad alto carico e due anelli in alluminio di dimensione diversa per il recupero dal basso.
- Disponibile in 3 lunghezze (90, 140 e 230 cm) con colori differenziati (rispettivamente giallo, nero e rosso).
- Oltre alle dimensioni standard è possibile, su richiesta, chiedere lunghezze personalizzate.



## LANYARD BULL



## ARO SLING TUBULAR

- Polyamide sling perfect for making a divert or to extend an anchor point. The product is supplied in different colors according to length.
- Anello di fettuccia in polyammide. Per realizzare una sosta o un ancoraggio, o prolungare un punto di ancoraggio. Il prodotto è fornito in diversi colori in base alle lunghezze. Disponibili anche misure personalizzate su richiesta.



#	CE	Color	Material	g	KN	cm
<b>ARO BULL</b>						
280A030NOKK	EN 795B - EN 354 - EN 566	■	polyamide	52	35	30
280A060R0KK	EN 795B - EN 354 - EN 566	■	polyamide	95	35	60
280A080Y0KK	EN 795B - EN 354 - EN 566	■	polyamide	130	35	80
280A120R0KK	EN 795B - EN 354 - EN 566	■	polyamide	185	35	120
280A150Y0KK	EN 795B - EN 354 - EN 566	■	polyamide	230	35	150
280A180R0KK	EN 795B - EN 354 - EN 566	■	polyamide	270	35	180
<b>LANYARD BULL</b>						
281A060R0KK	EN 795B - EN 354 - EN 566	■	polyamide	60	25	60
281A080N0KK	EN 795B - EN 354 - EN 566	■	polyamide	75	25	80
281A120Y0KK	EN 795B - EN 354 - EN 566	■	polyamide	115	25	120
281A150R0KK	EN 795B - EN 354 - EN 566	■	polyamide	130	25	150
281A180N0KK	EN 795B - EN 354 - EN 566	■	polyamide	155	25	180

#	CE	Color	Material	g	KN	cm
<b>TREE FORK</b>						
210A090Y0KK	EN 795B - EN 354 - EN 566	■	polyamide	230	25	90
210A140N0KK	EN 795B - EN 354 - EN 566	■	polyamide	305	25	140
210A230R0KK	EN 795B - EN 354 - EN 566	■	polyamide	435	25	230
<b>ARO SLING TUBULAR</b>						
271T030R0KK	EN 795B - EN 354 - EN 358 - EN 566	■	polyamide	15	23	30
271T060G0KK	EN 795B - EN 354 - EN 358 - EN 566	■	polyamide	28	23	60
271T080O0KK	EN 795B - EN 354 - EN 358 - EN 566	■	polyamide	38	23	80
271T120R0KK	EN 795B - EN 354 - EN 358 - EN 566	■	polyamide	57	23	120
271T150Y0KK	EN 795B - EN 354 - EN 358 - EN 566	■	polyamide	71	23	150
271T180N0KK	EN 795B - EN 354 - EN 358 - EN 566	■	polyamide	86	23	180

## TOOL LEASH / Y TOOL LEASH

**NEW**

- Elastic lanyard for attaching work tools such as a hammer, screwdriver, camera, etc...
- Equipped with a mini connector for the tool and an adjustable loop to connect it to the harness.
- Available in single or double arm.
- Not for human support.
- Longe elastica per collegare all'imbrago attrezzi da lavoro tipo martello, chiavi, piccozza, ecc...
- Dotata di un mini connettore da collegare all'attrezzo e un'asola con fibbia regolabile per connetterla all'imbrago.
- Disponibile in versione a braccio singolo e a Y.
- Non adatta per la sospensione.



## ARO SLING DYNEEMA®

- Dyneema® slings, lighter than polyamide slings.
- Available in various sizes.
- Excellent abrasion-resistance.
- Very useful for creating anchor or positioning points.
- Anello di fettuccia in Dyneema®, più leggero degli anelli in poliammide.
- Disponibile in varie misure.
- Ottima resistenza all'abrasione.
- Utile per creare punti di ancoraggio o di posizionamento.



#	CE	Color	Material	g	KN	cm
<b>TOOL LEASH</b>						
885050000KK	-	■	nylon	40	-	85-130
<b>Y TOOL LEASH</b>						
885020000KK	-	■	nylon	105	-	85-130
<b>ARO SLING DYNEEMA®</b>						
271D030R0KK	EN 795B - EN 354 - EN 566 - EN 358	■	dyneema®	27	22	30
271D060X0KK	EN 795B - EN 354 - EN 566 - EN 358	■	dyneema®	28	22	60
271D080B0KK	EN 795B - EN 354 - EN 566 - EN 358	■	dyneema®	38	22	80
271D120R0KK	EN 795B - EN 354 - EN 566 - EN 358	■	dyneema®	57	22	120
271D150X0KK	EN 795B - EN 354 - EN 566 - EN 358	■	dyneema®	71	22	150
271D180B0KK	EN 795B - EN 354 - EN 566 - EN 358	■	dyneema®	86	22	180

## Y ARO

- Dyneema® lanyard designed to help pass rebelay and for positioning during rescue manoeuvres.
- Equipped with arms of different lengths.
- Abrasion resistant webbing with reinforced eyelets.
- Longe in Dyneema® concepita per passare i frazionamenti e per il posizionamento nelle manovre di soccorso.
- Dotata di bracci di diversa lunghezza.
- Fettuccia resistente all'abrasione con asole rinforzate.

## Y ARO SPELEO



## Y ARO RESCUE



**Connection through lark's foot knot**  
Connessione tramite nodo a bocca di lupo.

#	CE	Color	Material	g	KN	cm
<b>Y ARO SPELEO</b>						
276D040X1KK	EN 354 - EN 566 - EN 358 - EN 795/B	■	dyneema®	41	22	40/25
276D055X1KK	EN 354 - EN 566 - EN 358 - EN 795/B	■	dyneema®	45	22	50/30
276D060X1KK	EN 354 - EN 566 - EN 358 - EN 795/B	■	dyneema®	48	22	60/30
<b>Y ARO RESCUE</b>						
276D075B1KK	EN 354 - EN 566 - EN 358 - EN 795/B	■	dyneema®	55	22	60/30

## FIX SOLEYMIEUX

- Expansion bolts or to be glued with resin, to be used in conjunction with the plate Wide Soleymieux or with the special connector Soleymieux.
- Made of high quality stainless steel, resistant to corrosion and weathering.
- The SOLEYMIEUX system is an excellent alternative to traditional bolts and pitons because it reduces the aesthetical impact of the anchor point, a very useful solution, especially when working on historic buildings.
- Using a removable plate eliminates the risk that unauthorized persons could use the anchor point.
- Tasselli ad espansione o da resinare, da utilizzare in abbinamento alla piastrina Wide Soleymieux o al connettore Soleymieux.
- Realizzati in acciaio inossidabile di alta qualità, resistente agli agenti atmosferici e all corrosione.
- Il sistema SOLEYMIEUX è un ottima alternativa ai tradizionali chiodi e spit in quanto permette di ridurre l'impatto estetico del punto di ancoraggio, soluzione molto utile in particolare quando si lavora su edifici storici.
- Grazie alla possibilità di rimuovere la piastrina si elimina inoltre il rischio di utilizzo del punto di ancoraggio da parte di persone non autorizzate.

# 815.01



# 815.02



# 815.03



# 815.04



## WIDE SOLEYMIEUX

- Bolt hanger with a wire gate to help prevent accidental removal from the Fix Soleymieux bolt.
- Made of high quality stainless steel, resistant to corrosion and weathering.
- SOLEYMIEUX system is an excellent alternative to traditional bolts and pitons because it can reduce aesthetical impact of the anchor point, a very useful solution especially when working on historic buildings.
- Using a removable plate eliminates the risk that unauthorized persons could use the anchor point.
- Placchetta d'ancoraggio con leva a filo per prevenire la fuoriuscita della placchetta dal perno Fix Soleymieux.
- Realizzata in acciaio inossidabile di alta qualità, resistente agli agenti atmosferici e all corrosione
- Il sistema SOLEYMIEUX è un ottima alternativa ai tradizionali chiodi e spit in quanto permette di ridurre l'impatto estetico del punto di ancoraggio, soluzione molto utile in particolare quando si lavora su edifici storici.
- Grazie alla possibilità di rimuovere la piastrina si elimina inoltre il rischio di utilizzo del punto di ancoraggio da parte di persone non autorizzate.

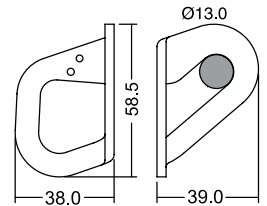

For SOLEYMIEUX # 761.SET.SL. pag. 84  
Per SOLEYMIEUX # 761.SET.SL. pag. 84



#	CE	Material	Color	g	kN	mm	Ø mm
815010000KK	-	stainless steel		62	-	90	10
815020000KK	-	stainless steel		95	-	100	12
815030000KK	-	stainless steel		55	-	90	10
815040000KK	-	stainless steel		88	-	100	12

#	CE	Material	Color	g	kN	mm	Ø mm
701500000KK	EN 795B EN 959	stainless steel		70	-	-	13

## WIDE EYE

- Anchor plate, made of high quality stainless steel weather resistant.
- Certified EN 795/B.
- For rescue and work at height.
- Available in 3 sizes.
- Available also the anchoring kit composed of an anchor plate and an expansion plug certified EN 959.
- Piastrina di ancoraggio in acciaio inossidabile di alta qualità resistente agli agenti atmosferici.
- Certificata EN 795/B.
- Per soccorso e lavori in quota.
- Disponibile in 3 misure.
- Disponibile anche kit composto da piastrina + tassello ad espansione certificato EN 959.

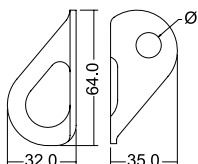

## DANCER

- Aluminum swivel, prevents ropes from twisting during the suspension of a load.
- Fluid movement through ball bearing.
- High tensile strength, 42 kN!
- Certification: CE EN 354.
- Girello in alluminio che evita l'attorcigliamento della corda durante la sospensione di un carico.
- Movimento fluido grazie al cuscinetto a sfere.
- Alto carico di rottura, ben 42 kN!
- Certificazione: CE EN 354.

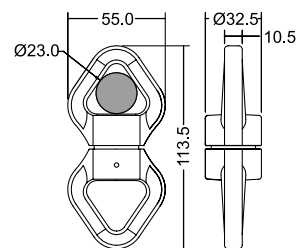

**Ball bearing.**  
Cuscinetto a sfera.

## ANA

- Aluminum connection ring, available in two sizes (28 and 46 mm), tensile strength 25 kN.
- Marked with a serial number for perfect tracking for the life of the product.
- Anello di collegamento in alluminio, disponibile in due misure (28 e 46 mm), carico di rottura 25 kN.
- Marcatura con numero seriale univoco per un perfetto tracciamento della vita del prodotto.

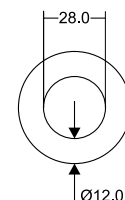
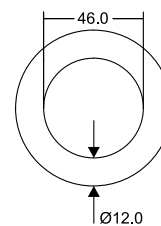

#	CE	Material	Color	g	kN	mm	Ø
89708000KK	EN 795/B	stainless steel	□	58	-	-	8
89710000KK	EN 795/B	stainless steel	□	55	-	-	10
89712000KK	EN 795/B	stainless steel	□	52	-	-	12

#	CE	Material	Color	g	kN	mm	Ø
<b>DANCER</b>							
948ON0400KK	EN 354	alu alloy	■	160	42	113,5	23
<b>ANA</b>							
930028000KK	-	alu alloy	■	40	25	-	28
930046000KK	-	alu alloy	■	60	25	-	46

## RIGGING PLATES

**NEW**

- 20mm diameter rigging plates, designed for a tidy workplace and to create an easy system of multiple anchor points.
- The upper hole can accommodate two carabiners at the same time.
- Made of light aluminum alloy, very light, compact and durable.
- New 10 mm thick version with beveled holes that allow textile items (rope, lanyards, straps) to be directly inserted without the need for connectors.
- Moltiplicatori di ancoraggio concepiti per organizzare una postazione di lavoro ordinata e creare un facile sistema di ancoraggi multipli.
- Il foro superiore permette di ospitare due connettori.
- Realizzate in lega leggera di alluminio, molto leggera, compatta e resistente.
- Nuova versione con spessore aumentato a 10 mm e fori smussati che permettono l'inserimento diretto di dispositivi tessili (corde, cordini, fettucce) senza la mediazione di connettori.

### 3RIG

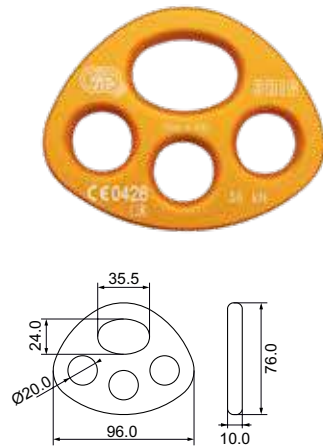

### 4RIG

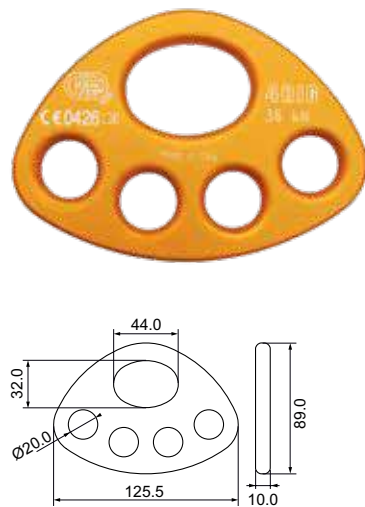

#	CE	Material	Color	g	kn
<b>3RIG</b>					
864O16400KK	CE	alu alloy	Orange	95	36
<b>4RIG</b>					
864O17400KK	CE	alu alloy	Orange	150	36

## FULL

- A belay plate that can be used in many different conditions.
- Innovative three hole rigging plate certified to EN 795/B for 5 people, it can also be used as a brake for rappelling with single or double ropes.
- It is a very useful device for rescue operations, the natural choice for mountain experts. It allows a cleaner belay point avoiding tricky and cumbersome chains of carabiners and plates. The wide upper hole is able to accommodate two connectors for greater safety. When used as a descender, it works with ropes from 8 to 12mm.
- Una piastrina d'assicurazione che può essere utilizzata anche come multi-ancoraggio.
- Innovativa piastrina multiancoraggi a tre fori certificata EN 795/B per 5 persone, utilizzabile anche come freno per la calata con corde doppie o singole.
- Perfetta per le manovre di soccorso, è lo strumento ideale per i professionisti della montagna. Permette una maggiore pulizia in sosta evitando complicate e ingombranti catene di moschettoni e freni. L'ampio foro superiore è in grado di alloggiare due connettori per una maggiore sicurezza. Come discensore funziona con corde da 8 a 12mm.

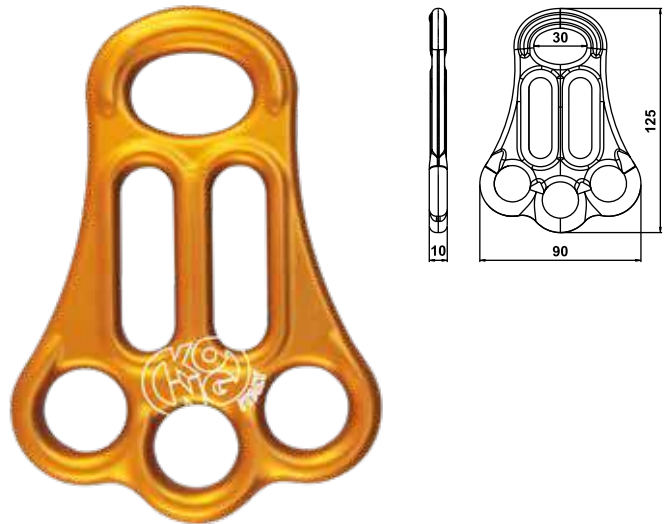

Retrieving / Recupero

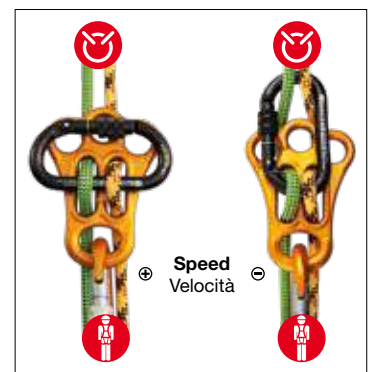

Rapelling / Calata

#	CE	Material	Color	g	Ø mm min.	Ø mm max.
864O15400KK	EN 795B - EN 15151-2 TS 16415	alu alloy	Orange	90	8	12
864N15400KK	EN 795B - EN 15151-2 TS 16415	alu alloy	Black	90	8	12



## RALLY

**NEW**

- New high strength 10 hole plate.
- 10 mm thickness with beveled holes that allow textile items (rope, lanyards, straps) to be directly inserted without the need for connectors.
- Compatible with all rigging products.
- Allows the creation of complex anchors; floating, braced, in series and in parallel.
- Available in a flat or curved version.
- Nuova piastra a 10 fori di elevata tenuta.
- Spessore 10 mm e fori smussati che permettono l'inserimento diretto di dispositivi tessili (corde, cordini, fettucce) senza la mediazione di connettori.
- Compatibile con tutti i prodotti da rigging.
- Consente la realizzazione di ancoraggi complessi, sospesi nel vuoto, controventati, in serie e in parallelo.
- Disponibile in versione piana e in versione ricurva.

### RALLY

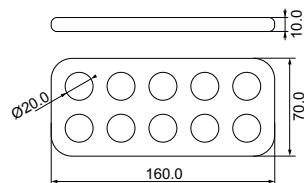

### RALLY BENT

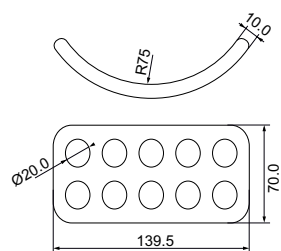
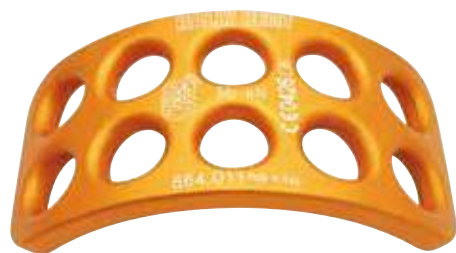

#	CE	Material	Color	g	kN
<b>RALLY</b>					
864O10400KK	CE	alu alloy		180	36
<b>RALLY BENT</b>					
864O11400KK	CE	alu alloy		180	36

## TEMPORARY LIFELINE

- Temporary horizontal lifeline with 30 mm width high-visibility webbing. Easy to install.
- It can be used for two persons simultaneously. The tensioner allows for easy installation by a single operator and guarantees an excellent grip without any damage to the webbing. The carry bag is stitched to the lifeline.
- Connectors not included.
- Linea vita temporanea orizzontale semplice da installare, con fettuccia in Poliestere da 30mm ad alto carico e alta visibilità.
- Permette di collegare allo stesso tempo due operatori. Il tensionatore permette ad un solo operatore di installare agevolmente il kit e garantisce un'eccellente tenuta senza danneggiare il nastro. La linea vita è cucita all'apposito contenitore per il trasporto.
- Connettori non inclusi.



**Max 20 m.**  
Massimo 20 m.

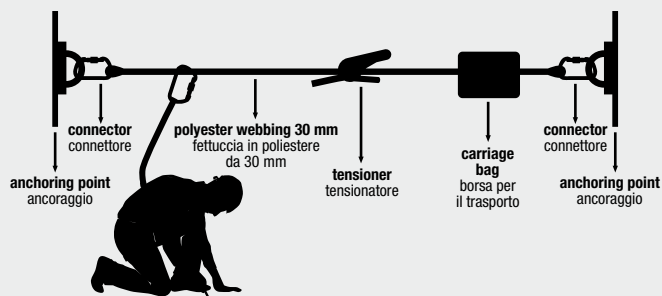

#	CE	Material	Color	g
206020000KK	EN 795C	polyester		3000

## CEVEDALE MONO (1 winch/argano)

- This tripod stand (which requires the use of textile ropes, both static and dynamic) has been designed for civil operations (sewers, confined spaces, buildings, etc...)
- As for safety, it makes the operation easier and much more flexible than any other technology employing steel cables.
- Cevedale Mono is made with tubes of aluminium alloy, assembled with stainless steel screws. The winches are manufactured with bronze and stainless steel components, while the drum is made of hard anodised aluminium.
- Light and compact, it can be carried on one's backs.
- Together with its fittings it weighs about 20 kg; during transportation, closed in the strong PVC bag, its size is 130x45x30 cm.
- The telescopic legs can be lengthened (3 positions for a total height of 160 to 200 cm) and are equipped with anti-slip supports which allow a wide opening and a perfect standing on any uneven and inclined ground.
- This tripod stand, together with a static textile rope, dia 10.5 mm as per the norm EN 1891, is in conformity with the Regulation 89/392/EEC and the norm EN 1496 as a device belonging to the class B.
- Supplied with accessories (n° 3 Ovalone Carbon screw sleeve connectors, n° 1 Heavy Duty pulley, n° 1 Back-up, carriage bag).
- Questo cavalletto (che prevede l'uso esclusivo di corde tessili, di tipo sia statico sia dinamico) è stato studiato per gli interventi in ambiente urbano (tombini, ambienti confinati, edifici, ecc...).
- In termini di sicurezza, consente manovre molto più agevoli e duttili di quelle che prevedono l'uso di cavi d'acciaio.
- Il cavalletto è costruito con tubi di lega d'alluminio, assemblati con viti d'acciaio inox. Gli argani sono fabbricati con componenti di bronzo marino e acciaio inox. Mentre il tamburo è in alluminio anodizzato a spessore.
- Leggero e compatto è facilmente trasportabile a spalla.
- Il suo peso, completo d'accessori è di 20 kg circa; richiuso nella resistente sacca in PVC per il trasporto misura 130x45x30 cm.
- Le piantane telescopiche sono allungabili (3 posizioni per un'altezza totale da 160 a 200 cm) e sono dotate di base antiscivolo che permette un'ampia apertura ed un perfetto adattamento ad ogni asperità e inclinazione del terreno.
- Questo cavalletto, abbinato ad una corda tessile di tipo statico di diametro 10,5 mm conforme alla norma EN 1891, risponde alla Direttiva 89/392/CEE ed alla norma EN1496 come dispositivo di classe B.
- Dotato di accessori (n° 3 connettori Ovalone Carbon a vite, n° 1 carrucola Heavy Duty, n° 1 Back-Up, sacca per trasporto).

## CEVEDALE BASE (no winch/argano)

- Cevedale Base is an anchor point certified CE EN 795/B which allows to descend safely in manholes and other confined spaces where there is no other possibilities of anchoring.
- Cevedale Base is made with tubes of aluminium alloy, assembled with stainless steel screws.
- Light and compact, it can be carried on one's backs.
- Together with its fittings it weighs about 14 kg; during transportation, closed in the strong PVC bag, its size is 130x45x30 cm.
- The telescopic legs (3 positions for a total height from 160 to 200 cm) are equipped with anti-slip supports which allow a wide opening and a perfect standing on any uneven and inclined ground.
- Supplied with n° 1 HMS screw sleeve connector.
- Cevedale Base è un treppiede omologato CE EN 795/B che permette di calarsi in sicurezza in tombini e spazi ristretti quando non esistono altre possibilità di ancorarsi.
- Il cavalletto è costruito con tubi di lega d'alluminio, assemblati con viti d'acciaio inox.
- Leggero e compatto è facilmente trasportabile a spalla.
- Il suo peso, completo d'accessori è di 14 kg circa; richiuso nella resistente sacca in PVC per il trasporto misura 130x45x30 cm.
- Le piantane telescopiche sono allungabili (3 posizioni per un'altezza totale da 160 a 200 cm) e sono dotate di base antiscivolo che permette un'ampia apertura ed un perfetto adattamento ad ogni asperità e inclinazione del terreno.
- Fornito con n° 1 connettori HMS a vite.

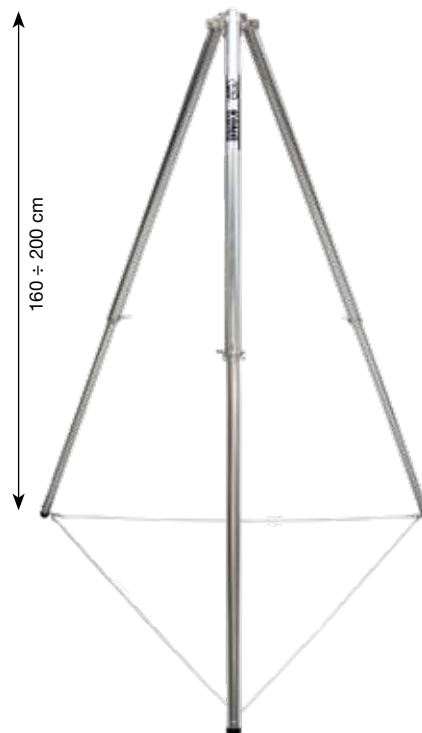

#	CE	Material	Color	kg
842010000KK	EN 1496/B - EN 795/B	alu alloy	□	20

#	CE	Material	Color	kg
842020000KK	EN 795/B	alu alloy	□	14

## GRIZZLY

- KONG GRIZZLY, used as a component of a retrieval system, allows lifting and lowering of loads (worker and tools) by positioning on the edge of a wall and avoiding the rubbing of the ropes against obstacles.
- Thanks to the rotary movement of the structure, GRIZZLY makes the recovery of loads easier.
- Fitted with reversible feet to ensure the perfect grip on the ground, either on slippery (clawed side) and on smooth surfaces (rubber side).
- Easy to disassemble and transportable in the special shoulder bag.
- KONG GRIZZLY, utilizzato come componente di un sistema di recupero, permette di calare o sollevare carichi (operatore e attrezzatura), posizionandosi sul ciglio di una parete evitando lo sfregamento delle corde contro ostacoli.
- Grazie al movimento rotativo della struttura, facilita la fase finale di messa in sicurezza del carico recuperato.
- Dotato di piedi reversibili che garantiscono la perfetta aderenza al terreno, sia su fondi sdrucchiolevoli (lato artigliato) sia su fondi lisci (lato gommato).
- Facilmente smontabile e trasportabile a spalla nell'apposita sacca.

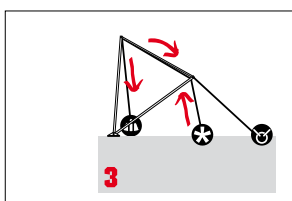
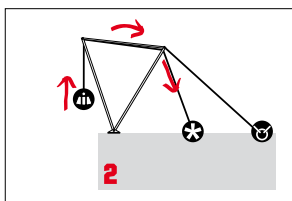
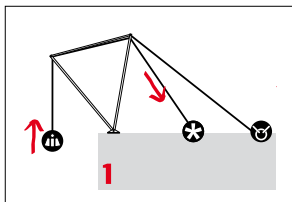
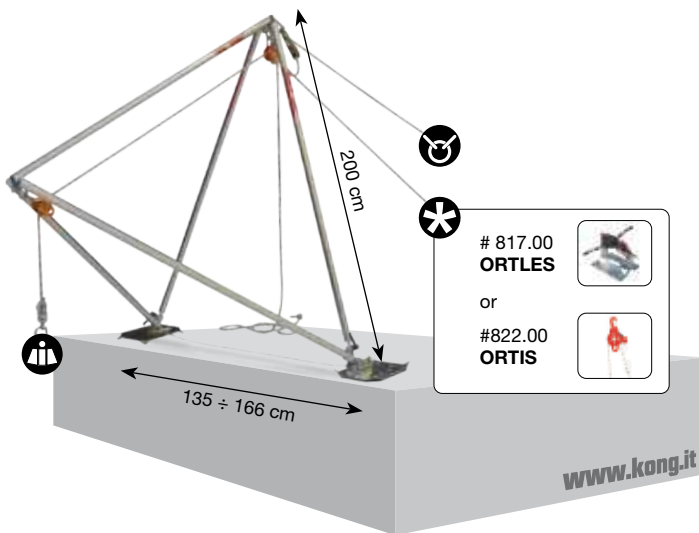

#	€	Material	Color	kg
81740000KK	-	alu alloy	□	15

## MINI STELVIO 4D

NEW

- Mini Stelvio 4D is a complex piece of equipment which is highly useful in handling loads or people, for both work and in organized technical rescue.
- The pole is telescopic, with a hinged joint at the base which can pivot in 4 directions while allowing loaded ropes to slide on its terminal pulleys.
- Equipped with reversible feet that ensure perfect grip both on slippery surfaces (clawed side) and smooth surfaces (rubberized side).
- Thanks to its compact size, it is easy to disassemble and carry in the shoulder bag provided.
- Mini Stelvio 4D è un'attrezzatura complessa di grande utilità nella movimentazione di carichi o persone, nel lavoro e nel soccorso tecnico organizzato.
- Il palo è telescopico, controventabile in quattro direzioni anche contemporaneamente consentendo anche lo scorrimento delle funi di carico su pulegge terminali.
- Dotato di piedi reversibili che garantiscono la perfetta aderenza al terreno, sia su fondi sdrucchiolevoli (lato artigliato) sia su fondi lisci (lato gommato).
- Grazie alle dimensioni compatte è facilmente smontabile e trasportabile a spalla nell'apposita sacca.



#	€	Material	Color	kg
81750000KK	-	alu alloy	□ ■ ■	7.8

# 7

## What are they?

Lifting devices are complex equipment, normally composed of multiple components, which have the function of lifting and lowering a load - human and/or material. They are normally equipped with systems that reduce the force necessary for lifting, and one or more safety systems which avoid the accidental loss of the load. Kong offers winches made with components of the highest quality, and when used in combination with specific accessories (pole, tripod, bipod, bases, etc...) are used to perform various functions - from rescue, to moving loads, to moving in confined spaces, to lowering of big branches in arboriculture operations.

## Cosa sono?

I dispositivi di sollevamento sono attrezzature complesse, normalmente composte da più componenti, che hanno la funzione di sollevare e calare un carico, umano e/o materiale. Sono normalmente dotati di sistemi di demoltiplicazione che riducono la forza necessaria per effettuare il sollevamento, e di uno o più sistemi di sicurezza che evitano la perdita accidentale del carico. Kong propone degli argani prodotti con componentistica di altissimo livello, che utilizzati in abbinamento ad accessori specifici (palo, tripode, bipode, basi, ecc...) permettono di assolvere alle più svariate funzioni, dal soccorso allo spostamento di carichi, dalla calata in ambienti confinati alla calata di grossi rami in operazioni di arboricoltura.



Cleaning of incinerator's chimney (Bolzano - Italy) - ph: Gabriel Kammerer

# LIFTING DEVICES DISPOSITIVI DI SOLLEVAMENTO

7



Ortles



Baobab



Mini Hoist



Maxi Hoist



Mega Hoist

## ORTLES

- The revolutionary ORTLES WINCH, nowadays a must in Europe rescue operations involving lowering and lifting, is fitted with a two-speed and Self-Tailing winch actuated by two handles.
- It is possible to change the winding speed (and power) easily and without delaying the rescue operation.
- Light and compact, it can be quickly disassembled for transport in its PVC bag.
- Using a stand, ORTLES can be fixed easily to the ground, rocks, or ice in a horizontal or vertical position. ORTLES can be fixed either onto a stand or onto the STELVIO by two screw pins.
- ORTLES can be used with knotted ropes.
- Il rivoluzionario sistema di recupero ORTLES è ormai uno standard operativo Europeo che permette il recupero e le calate in ogni situazione di soccorso. Argano a due velocità con Self Tailing azionato da due manopole.
- Possibilità di variare la velocità senza interrompere il recupero.
- Leggero e compatto è facilmente smontabile per il trasporto nel suo sacco/zaino.
- Grazie ai supporti/basi può essere facilmente fissato sulle basi o sul palo pescante STELVIO velocemente con due spine di sicurezza.
- ORTLES può essere utilizzato con corde annodate.

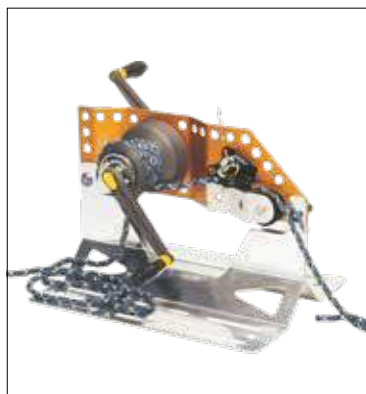

**ORTLES with STAND # 81720000KK**  
ORTLES con BASI



**ORTLES with STELVIO**  
ORTLES con STELVIO



**DRILL ADAPTER**  
# 81703000KK

#	CE	Material	kg
81700000KK	EN 1496	alu alloy	6

## BAOBAB

- System for lifting and rope frictioning during tree care. It allows safe operation when lowering cut branches. Shall be used with textile ropes or ropes with metallic core. Do not use with wire cables. Quick operation is achievable with the first reduced speed, when load then increases, simply wind in the opposite direction and second gear and maximum power is automatically selected. Fitted with self-tailing.
- Sistema di sollevamento e frizionamento corde per abbattimento alberi. Consente di operare in sicurezza permettendo di controllare la calata dei rami tagliati. Deve essere usato con corde tessili o con corde con anima in metallo. Non usare cavi metallici. Con il primo rapporto, pur realizzando notevoli potenze, si ha un recupero veloce; all'aumentare dello sforzo cambiando il verso di rotazione della monovella, si inserisce automaticamente la seconda velocità che realizza la massima potenza.

**!** On demand  
Su richiesta

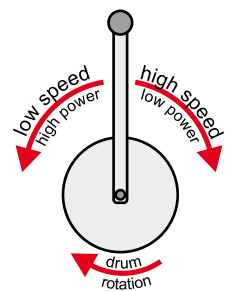



#	CE	Material	kg
979SET200KK	-	alu alloy	44,5

## MINI HOIST Size 7

- Preassembled system of a small size that allows a load to be lifted with a force equal to 1/7th of the load.
- A self-locking device prevents the return of the load to its previous position.
- Suitable to lift the load and avoid any constraints during evacuation.
- Especially suitable for evacuation in the adventure parks.
- Sistema preassemblato di dimensioni contenute che consente di sollevare un carico con una forza pari a 1/7 del carico stesso.
- Un apposito bloccante integrato impedisce il ritorno del carico nella posizione precedente.
- Adatto per alleggerire il carico ed eliminare eventuali vincoli ai fini dell'evacuazione.
- Particolarmente adatto all'evacuazione dai percorsi dei parchi avventura.





#	Ratio	 m	 Ø mm	 g
208001000KK	1/7	6,5	5	680

## MAXI HOIST Size 5

- Preassembled system that allows a load to be lifted using a force equal to 1/5th of the load.
- A self-locking device prevents the return of the load to its previous position.
- Very useful for:
  - evacuation from scaffolding;
  - lifting of rope workers;
  - recovery from confined spaces using a tripod or a bipod.
- Sistema preassemblato che consente di sollevare un carico applicando una forza pari a 1/5 del carico stesso.
- Un dispositivo autobloccante impedisce il ritorno del carico nella posizione precedente.
- Molto utile per:
  - manovre di evacuazione da ponteggi;
  - recupero verso l'alto di lavoratori su fune;
  - recupero da ambienti confinati con tripode o bipode.







#	Ratio	 m	 Ø mm	 g
208000000KK	1/5	15	10	1820

## MEGA HOIST Size 11

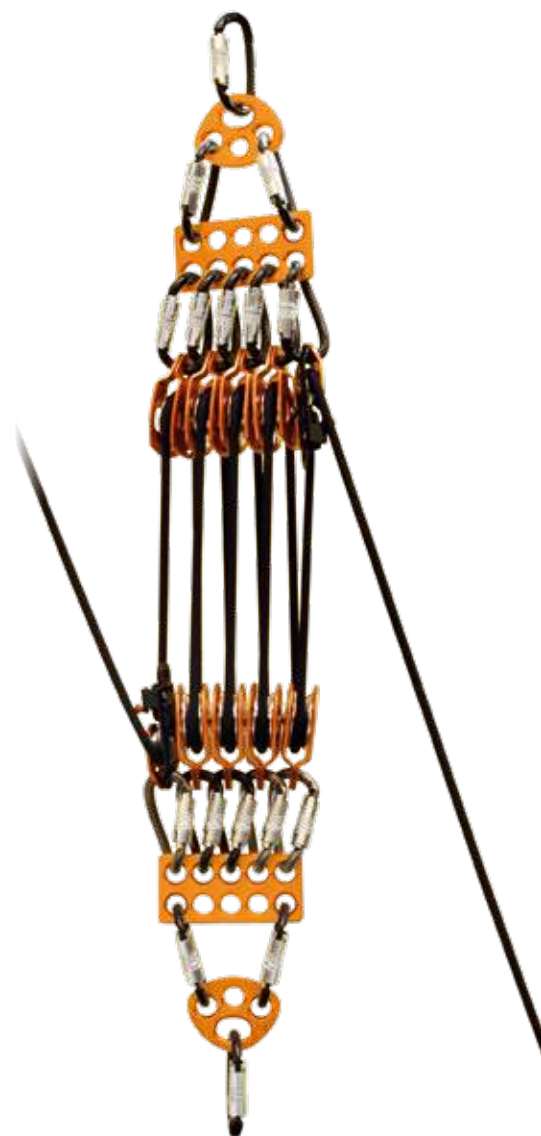
**NEW**

- Preassembled system for lifting loads by applying force equal to 1/11th of the load itself.
- Two self-locking devices prevent the load from returning to its previous position.
- Allows millimetric movement of heavy loads.
- Sistema preassemblato che consente di sollevare un carico applicando una forza pari a 1/11 del carico stesso.
- Due dispositivi autobloccanti impediscono il ritorno del carico nella posizione precedente.
- Permette lo spostamento millimetrico di grandi carichi.



#	Ratio	 m	 Ø mm	 kg
208100000KK	1/11	100	10	13.6

# 8

## Why choose a Kong connector?

- It is produced in Italy
- We have centuries-old experience, we have manufactured connectors since 1830
- All connectors are tested piece by piece
- We have a very wide range - in aluminum alloy, stainless steel, carbon steel, with screw sleeve, auto block, twist lock, special high-strength sleeve certified ANSI
- They are marked with a unique serial number for traceability
- Carbon steel versions have a special burnished surface finish that makes them more attractive, provides greater legibility of the marking and increases the durability
- For a minimum quantity, each connector can be customized with logos and corporate client colors

## Perché scegliere un connettore Kong?

- È prodotto in Italia
- Abbiamo un'esperienza ultra secolare, produciamo connettori dal 1830
- Tutti i connettori sono testati pezzo per pezzo
- Abbiamo una gamma vastissima – in lega d'alluminio, acciaio inox, acciaio al carbonio, con ghiera a vite, auto block, twist lock, speciali ghiera ANSI ultrasensibili
- Sono marcati con un numero di serie univoco ai fini della tracciabilità
- Le versioni in acciaio al carbonio hanno una speciale finitura superficiale brunita che oltre a renderli più accattivanti, garantisce una maggiore leggibilità della marcatura e una maggiore durata
- Per quantitativi minimi ogni connettore può essere personalizzato con loghi e colori istituzionali del cliente





# CONNECTORS CONNETTORI

8

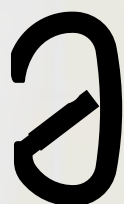

Oval



Asymmetric



HMS



Special



Quick Link

**Shape / Forma**

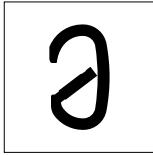

**OVAL / OVALE**

- Designed for lower loads.  
Connettore a chiusura automatica destinato a carichi minori.

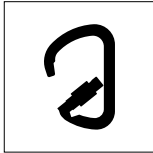

**ASYMMETRIC / ASIMMETRICO**

- Designed to orient the load in a predetermined direction on the connector's body.  
Connettore a chiusura automatica destinato ad assicurare il carico in una predeterminata direzione.

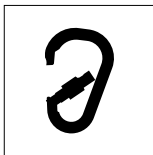

**HMS**

- HMS is an abbreviation of the German term Halbmastwurf-Sicherung, primarily intended for use when giving a dynamic belay using the "italian hitch" knot.  
Connettore a chiusura automatica, HMS è l'acronimo del termine tedesco Halbmastwurf-Sicherung, destinato principalmente ad una assicurazione dinamica usando un nodo "mezzo barcaiole".



**SPECIAL / SPECIALE**

- Connectors with complex shapes for a particular purpose; can in some cases be connected directly to a specific anchor type.  
Connettore a chiusura automatica con forme complesse destinato a utilizzi particolari; può in certi casi essere collegato direttamente ad un tipo di ancoraggio specifico.



**QUICK LINK / MAGLIA RAPIDA**

- Connector with a manual closing system, intended for those applications that do not require frequent removal.  
Connettore a chiusura manuale a vite destinato a quegli impieghi dove non è richiesta la rimozione frequente.

**Materials / Materiali utilizzati**

**LIGHT ALLOY ALUMINUM / LEGA LEGGERA D'ALLUMINIO**

- Preferred in applications where minimum weight is necessary.  
Preferito negli impieghi dove è necessaria la massima leggerezza.

**STAINLESS STEEL / ACCIAIO INOX**

- Preferred for use in corrosive environments, it does not rust.  
Preferito per l'utilizzo in ambienti corrosivi, non fa ruggine.

**CARBON STEEL / ACCIAIO AL CARBONIO**

- Preferred for situations without specific needs thanks to the combination of high strength and lower cost.  
Preferito per situazioni senza specifiche esigenze grazie al minor costo d'acquisto.

**Sleeves / Ghiere di sicurezza**

**SCREW / VITE**

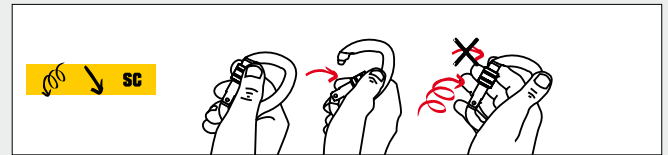

- This sleeve is commonly used for mountaineering. The Kong version is popular due to its quick operation. The sequence of movements is shown in the figures: 1. Unscrew; 2. Open; 3. Release; 4. Screw.  
Questa ghiera è quella comunemente utilizzata per l'alpinismo. La versione Kong è apprezzata perchè si aziona rapidamente. La sequenza dei movimenti è mostrata nelle figure: 1. svitare; 2. aprire; 3. rilasciare; 4. avvitare.

**TWIST LOCK**

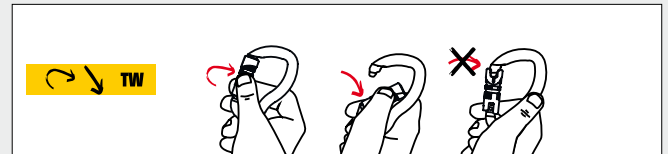

- (2 movements) - The twist lock sleeve is optimal for safety and convenience. For this reason, it is preferred in rescue operations and for industrial use. Available in ANSI certified version (United States standard).  
(2 movimenti) - La ghiera twist-lock è ottimale per sicurezza e praticità. Per questo motivo è preferita nelle operazioni di soccorso e per usi industriali. Disponibile in versione omologata ANSI (normativa USA).

**AUTO BLOCK**

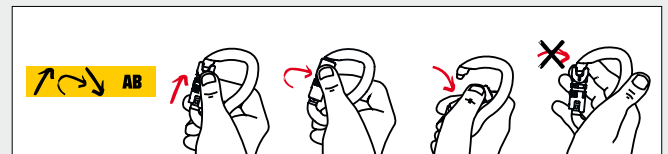

- (3 movements) - This sleeve requires three movements to open the gate and is therefore intended to fulfill the most difficult tasks. Available in ANSI certified version (United States standard).  
(3 movimenti) - Questa ghiera richiede tre movimenti per l'apertura e quindi è destinata ad assolvere i compiti più ardui. Disponibile in versione omologata ANSI (normativa USA).

**DOUBLE GATE**

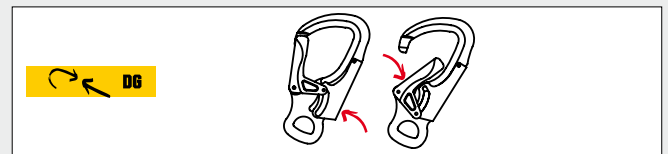

- This system is preferred for applications that require frequent openings, as on lifelines, because it is secure and easy to use.  
Questo sistema è preferito per un uso ripetuto, come avviene sulle linee vita, perchè viene azionato in modo rapido e semplice.

## General Safety Remarks

**Warning:** The maximum tolerated load marked on the connectors is very close to the breaking point. Connectors supporting this stress will be permanently deformed and absolutely must be replaced. See the following pictures for connector and sleeve testing.

**Attenzione:** sui connettori é marcato il carico massimo garantito, molto vicino a quello di rottura. Un connettore sottoposto a tale carico si deforma permanentemente e deve essere assolutamente sostituito. I connettori e le ghiere vengono testati come riportato nelle seguenti illustrazioni.

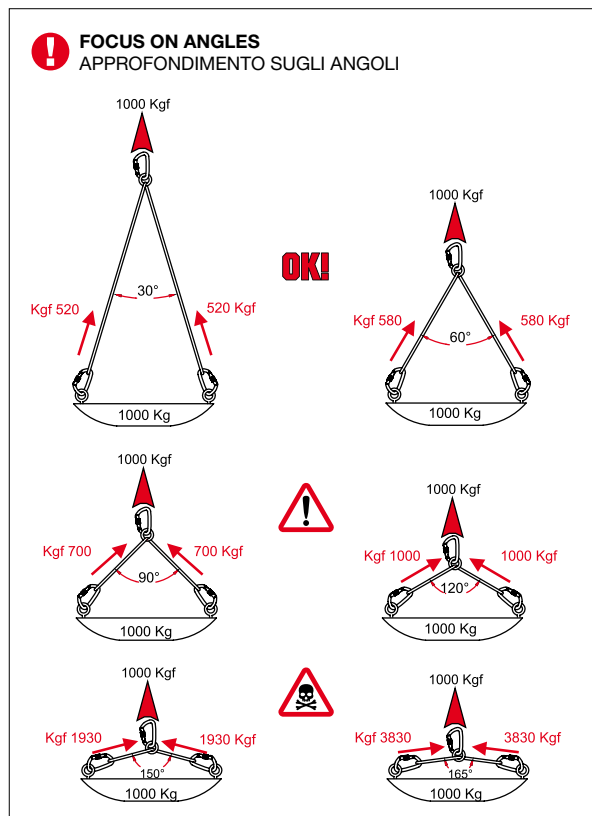
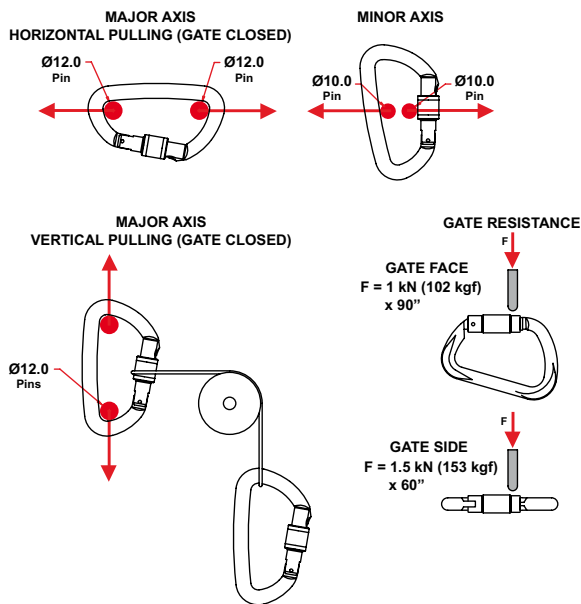

**All our connectors are tested piece by piece.**  
 Tutti i nostri connettori sono testati pezzo per pezzo.



Watch the video  
Guarda il video

**OVALONE** **KEYLOCK**

- Oval connector wide opening. Ideal for heavy duty applications and for connection to structural anchors, lifelines, etc...
- Available in carbon steel, stainless steel and light aluminum alloy versions, with screw sleeve, autoblock and twistlock sleeves standard version and high load ANSI certified.
- Equipped with keylock system.

- Connettore ovale ad ampia apertura. Ideale per impieghi gravosi e per il collegamento ad ancoraggi strutturali, linee vita, ecc...
- Disponibile in acciaio al carbonio, acciaio inossidabile e lega leggera d'alluminio, con ghiera a vite, autoblock e twist lock standard e ad alto carico certificata ANSI.
- Dotato di sistema keylock.



**CARBON STEEL**  
**screw sleeve**

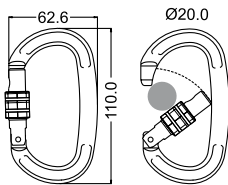

**STAINLESS STEEL**  
**Screw sleeve**

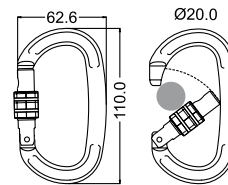

**CARBON STEEL**  
**auto block**  
**twist lock**

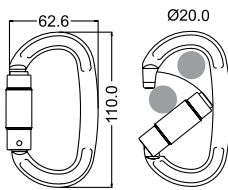

**STAINLESS STEEL**  
**auto block**  
**twist lock**

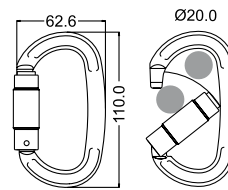

**CARBON STEEL ANSI**  
**auto block**  
**twist lock**

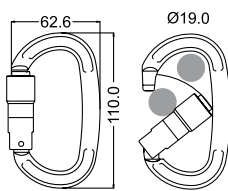

**STAINLESS STEEL ANSI**  
**auto block**  
**twist lock**

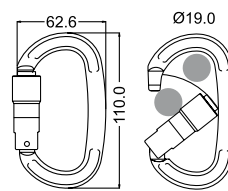

#		CE	Color		kN	kN	kN	g
<b>Carbon steel screw sleeve</b>								
412110ZL1KK	•	EN 12275/B NFPA-G - EN 362/M			40	15	12	205
<b>Carbon steel auto block</b>								
412110ZYKZKK	•	EN 12275/B NFPA-G - EN 362/M			40	15	-	215
<b>Carbon steel twist lock</b>								
412110ZZKZKK	•	EN 12275/B NFPA-G - EN 362/M			40	15	-	215
<b>Carbon steel ANSI auto block</b>								
412110ZOZKZKK	•	EN 12275/B NFPA-G - EN 362/M ANSI Z359.12			40	20	-	230
<b>Carbon steel ANSI twist lock</b>								
412110ZTZKZKK	•	EN 12275/B NFPA-G - EN 362/M ANSI Z359.12			40	20	-	230

#		CE	Color		kN	kN	kN	g
<b>Stainless steel screw sleeve</b>								
5121100L3KK	•	EN 362/B			27	-	-	215
<b>Stainless steel auto block</b>								
5121100Y3KK	•	EN 362/B			27	-	-	230
<b>Stainless steel twist lock</b>								
5121100Z3KK	•	EN 362/B			27	-	-	230
<b>Stainless steel ANSI auto block</b>								
5121100K1KK	•	EN 362/M ANSI 359.12:2009			27	-	-	240
<b>Stainless steel ANSI twist lock</b>								
5121100I1KK	•	EN 362/M ANSI 359.12:2009			27	-	-	240





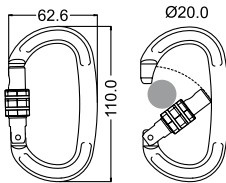



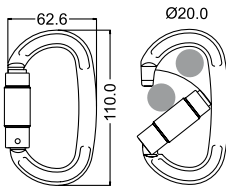







**ALU ALLOY**  
Screw sleeve



**ALU ALLOY**  
auto block  
twist lock



#		CE	Color 	 kN	 kN	 kN	 g
<b>Alu alloy screw sleeve</b>							
712ON06AOKK	•	EN 362/B EN 12275/B		26	9	8	72
7120001A1KK	•	EN 362/B EN 12275/B		26	9	8	72
712RNP4A1KK	•	EN 362/B EN 12275/B		26	9	8	72
<b>Alu alloy auto block</b>							
712OPN7VNKK	•	EN 362/B EN 12275/B		26	9	-	77
712RPP3V1KK	•	EN 362/B EN 12275/B		26	9	-	77
712NNN6VNKK	•	EN 362/B EN 12275/B		26	9	-	77
<b>Alu alloy twist lock</b>							
712OPN7PNKK	•	EN 362/B EN 12275/B		26	9	-	77
712RPP3P1KK	•	EN 362/B EN 12275/B		26	9	-	77
7120001P1KK	•	EN 362/B EN 12275/B		26	9	-	77

# OVALONE DNA

**NEW**

- Special "helical-shaped" connector with a twisted body and circular bar, a must-have when an "offset" load is required.
- It permits 90° rotation of any connected device (descenders, rope clamps, fall arresters, etc.), optimizing the operating alignment.
- Speciale connettore "elicoidale" con corpo ritorto a sezione circolare, essenziale quando è richiesto un carico "disassato".
- Consente di ruotare di 90° qualsiasi dispositivo venga inserito (discensori, bloccanti, anticaduta, ecc...), ottimizzandone la condizione operativa.



**CARBON STEEL**  
auto block  
twist lock

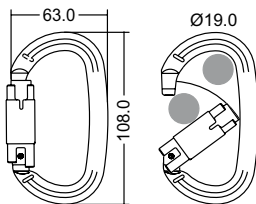

**CARBON STEEL *ANSI***  
auto block  
twist lock

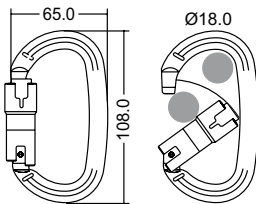

Watch the video  
Guarda il video

#			Color				
<b>Carbon steel auto block</b>							
414110ZYZZK	-	EN 362/B		40	7	12	215
<b>Carbon steel twist lock</b>							
414110ZZZZK	-	EN 362/B		40	7	12	215
<b>Carbon steel ANSI auto block</b>							
414110ZOZZK	-	EN 362/M ANSI/ASSE Z359.12		40	16	12	230
<b>Carbon steel ANSI twist lock</b>							
414110TZZZK	-	EN 362/M ANSI/ASSE Z359.12		40	16	12	230



## OVAL CLASSIC

- Oval carabiner available in alu alloy and carbon steel versions with a circular rod. It is recommended for use with mobile devices (pulleys, blockers, fall arresters...).
- Equipped with a screw sleeve and suitable for professional applications.
- The Keylock system prevents any accidental entanglement in the rope or anchor point.
- Connettore ovale disponibile in alluminio e acciaio al carbonio, con corpo a sezione circolare che lo rende consigliato per l'utilizzo con dispositivi mobili (carrucole, bloccanti, anticaduta...).
- Dotato di ghiera a vite che lo rende utilizzabile anche per applicazioni professionali
- Sistema keylock che evita qualunque impiglio accidentale della corda o nel punto di ancoraggio.



**CARBON STEEL  
screw sleeve**

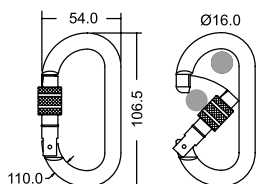

**ALU ALLOY  
screw sleeve**

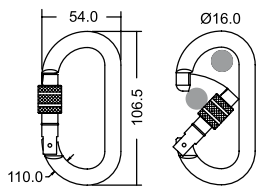









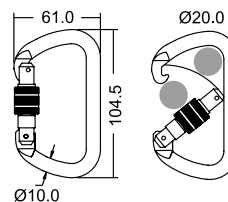

## OVAL D STEEL





- Oval connector made of carbon steel with a wide opening and screw sleeve.
- The particular D shape prevents connector rotation and allows most of the load to be weighted along the major axis.
- Connettore ovale in acciaio al carbonio ad ampia apertura con ghiera a vite.
- La particolare forma a D evita la rotazione del connettore e permette di ripartire maggiormente il carico lungo l'asse più robusto.



**CARBON STEEL TEMPERED  
screw sleeve**



#			Color 	
<b>Carbon steel screw sleeve</b>				
462100ZC1KK	•	EN 12275 EN 362/B		24 10 7 176
<b>Alu alloy screw sleeve</b>				
730ON06AOKK	•	EN 12275 EN 362/B		22 7 7 65
7300001A1KK	•	EN 12275 EN 362/B		22 7 7 65
730BPP3A1KK	•	EN 12275 EN 362/B		22 7 7 65
730NNN6ANKK	•	EN 12275 EN 362/B		22 7 7 65
730RPP3A1KK	•	EN 12275 EN 362/B		22 7 7 65

#			Color 	
<b>Carbon steel tempered screw sleeve</b>				
465100ZC1KK	•	EN 12275 NFPA-G EN 362/M		42 15 11 170

**X-LARGE**

- Connector with a wide opening and high tensile strength. The D shape prevents carabiner rotation and allows the load to be distributed along the major axis.
- Available in different materials (alu alloy, carbon steel and stainless steel) and with different sleeves (screw, autoblock and twist-locks, also conform to ANSI norm).
- A carbon steel version is available with a special burnished finishing that allows greater visibility of the laser marking.

- Connettore con ampia apertura ed elevato carico di rottura. La forma a D evita la rotazione del connettore e permette di distribuire il carico lungo l'asse maggiore.
- Disponibile in differenti materiali (lega d'alluminio, acciaio al carbonio e acciaio inox) e con diverse ghiera (a vite, autoblock e twistlock anche in versione certificata ANSI)
- Nella versione in acciaio al carbonio è disponibile la speciale finitura brunita che permette una maggiore visibilità della marcatura.



**CARBON STEEL**  
screw sleeve

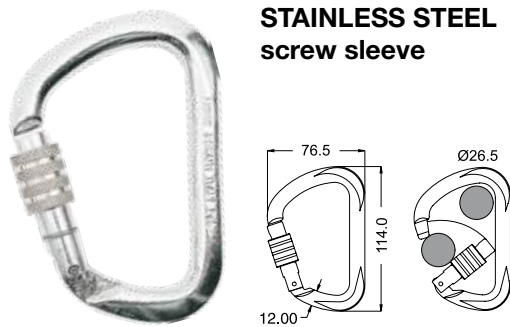

**STAINLESS STEEL**  
screw sleeve



**CARBON STEEL**  
auto block  
twist lock

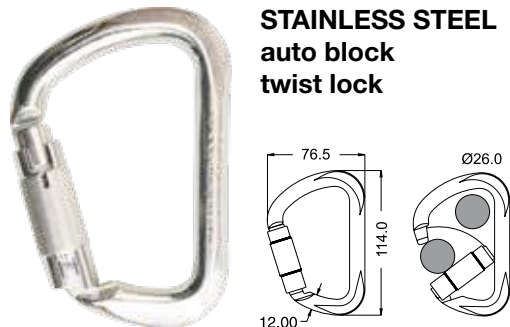

**STAINLESS STEEL**  
auto block  
twist lock



**CARBON STEEL ANSI**  
auto block  
twist lock

#		CE	Color				
<b>Carbon steel screw sleeve</b>							
411120ZL1KK	•	EN 12275/B EN 362/B		50	13	20	240
<b>Carbon steel auto block</b>							
411120ZYKZKK	•	EN 12275/B EN 362/B		50	13	-	240
<b>Carbon steel twist lock</b>							
411120ZZKZKK	•	EN 12275/B EN 362/B		50	13	-	240
<b>Carbon steel ANSI auto block</b>							
411120ZOZKZKK	•	EN 12275/B NFPA-G - EN 362/M ANSI 359.12		50	20	-	265
<b>Carbon steel ANSI twist lock</b>							
411120ZTZKZKK	•	EN 12275/B NFPA-G - EN 362/M ANSI 359.12		50	20	-	265

#		CE	Color				
<b>Stainless steel screw sleeve</b>							
5111200L3KK	•	EN 12275/B EN 362/B		35	11	-	240
<b>Stainless steel auto block</b>							
5111200Y3KK	•	EN 12275/B EN 362/B		35	11	-	255
<b>Stainless steel twist lock</b>							
5111200Z3KK	•	EN 12275/B EN 362/B		35	11	-	255





## HARNESS

- Asymmetrical carbon steel connector available with screw, autoblock and twistlocks sleeves. Available also in aluminum alloy and stainless steel.
- Perfect for use with positioning lanyards.
- Connettore asimmetrico in acciaio al carbonio disponibile con ghiera a vite, autoblock e twistlock. Disponibile anche in lega d'alluminio, e acciaio inox
- Perfetto per utilizzo con longe di posizionamento.



**ALU ALLOY  
screw sleeve**

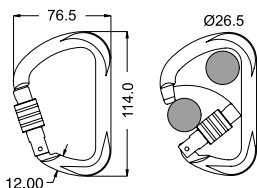

**ALU ALLOY  
auto block  
twist lock**

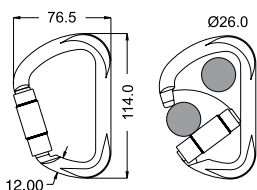



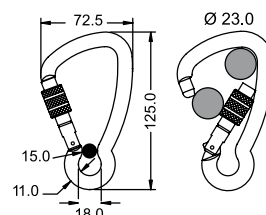



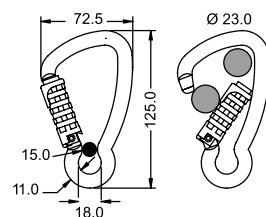

















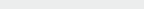

**CARBON STEEL  
screw sleeve**



**CARBON STEEL  
auto block**



#		CE	Color 		kN	kN	kN	g
<b>Alu alloy screw sleeve</b>								
911ONO6AOKK	•	EN 12275/B EN 362/B			30	9	9	90
9110001A1KK	•	EN 12275/B EN 362/B			30	9	9	90
911NNN6ANKK	•	EN 12275/B EN 362/B			30	9	9	90
911RXP4A1KK	•	EN 12275/B EN 362/B			30	9	9	90
<b>Alu alloy auto block</b>								
911OPN7VNKK	•	EN 12275/B EN 362/B			30	9	-	95
911RPP3V1KK	•	EN 12275/B EN 362/B			30	9	-	95
<b>Alu alloy twist lock</b>								
911OPN7PNKK	•	EN 12275/B EN 362/B			30	9	-	95
911RPP3P1KK	•	EN 12275/B EN 362/B			30	9	-	95

#		CE	Color 		kN	kN	kN	g
<b>Carbon steel screw sleeve</b>								
436120ZC1KK	•	EN 362/B			22	7	-	217
<b>Carbon steel auto block</b>								
436120ZYZKK	•	EN 362/B			22	7	-	227



Available with eyelet (# 438XXXXXXKK).  
Disponibile con occhiello (# 438XXXXXXKK).

## HEAVY DUTY

- High tensile connector with screw sleeve.
- Heavy Duty Alu is the connector with the highest strength in our production range, with 60 kN (carbon steel version) on the major axis!
- The particular D shape prevents carabiner rotation and encourages load distribution along the strongest axis.
- Equipped with screw gate which makes it perfect for all professional applications.
- Connettore ad alto carico con ghiera a vite.
- Heavy Duty è il connettore con la più alta tenuta di carico della nostra produzione, ben 60 kN (versione in acciaio) e sull'asse maggiore!
- La particolare forma a D evita la rotazione del connettore e permette di ripartire maggiormente il carico lungo l'asse più robusto.
- Dotato di ghiera a vite che lo rende perfetto per tutte le applicazioni professionali.



**CARBON STEEL**  
screw sleeve

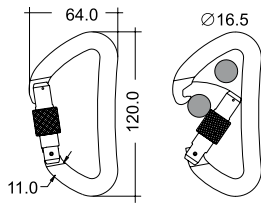

**ALU ALLOY**  
screw sleeve

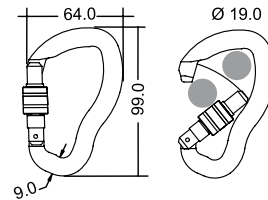

**ALU ALLOY**  
screw sleeve

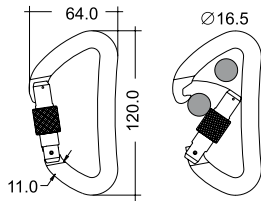

**ALU ALLOY**  
auto block  
twist lock

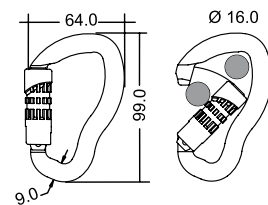

#			Color 				
<b>Carbon steel screw sleeve</b>							
472120ZC1KK	•	EN 12275/B EN 362/M		60	15	25	232
<b>Alu alloy screw sleeve</b>							
785NNN6ANKK	•	EN 12275/B EN 362/B		36	11	13	85

#			Color 				
<b>Alu alloy screw sleeve</b>							
7830001A1KK	•	EN 12275 EN 362/B - NFPA-P		27	10	9	58
783NCP4A1KK	•	EN 12275 EN 362/B - NFPA-P		27	10	9	58
783NNN6ANKK	•	EN 12275 EN 362/B - NFPA-P		27	10	9	58
<b>Alu alloy auto block</b>							
7830001V1KK	•	EN 12275 EN 362/B		27	7	-	67
<b>Alu alloy twist lock</b>							
7830001P1KK	•	EN 12275 EN 362/B		27	7	-	65



## FERRATA

- Aluminum connector available with a screw, auto block and twist lock sleeves.
- Fitted with the Keylock system. Its special shape grants a wide opening (26 mm!) and excellent grip.
- Normally used on lanyards for progression and positioning.
- Connettore in alluminio disponibile con ghiera a vite, autoblock e twistlock.
- Dotato di sistema keylock. La sua forma particolare consente una grande apertura (ben 26 mm!) e un'ottima impugnatura.
- Normalmente utilizzato su cordini di progressione e posizionamento.

## MINI D

- The smallest aluminum connector with a screw sleeve in our production.
- To be used for accessories and tools.
- Available in a straight gate version.
- Warning! Not for human support.
- Il più piccolo connettore in alluminio con ghiera a vite della nostra produzione.
- Da utilizzare come porta accessori e attrezzi.
- Disponibile anche in versione senza ghiera.
- Attenzione! Non adatto al supporto umano.



**ALU ALLOY  
screw sleeve**

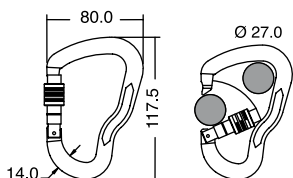

**STRAIGHT GATE**

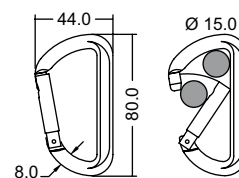



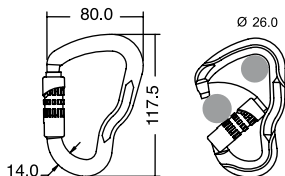



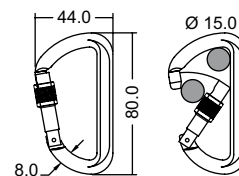

























**ALU ALLOY  
auto block  
twist lock**



























**SCREW SLEEVE**



 **Warning! Not suitable for human support.**  
Attenzione! Non adatto al supporto umano.

#			Color 	 kN	 kN	 kN	 g
<b>Alu alloy screw sleeve</b>							
7780001A1KK	•	EN 12275/K EN 362/B	  	30	10	12	90
778NNN6ANKK	•	EN 12275/K EN 362/B	  	30	10	12	90
<b>Alu alloy auto block</b>							
7780001V1KK	•	EN 12275/K EN 362/B	  	30	8	-	95
778NNN6VNKK	•	EN 12275/K EN 362/B	  	30	8	-	95
778RPP3V1KK	•	EN 12275/K EN 362/B	  	30	8	-	95
<b>Alu alloy twist lock</b>							
7780001P1KK	•	EN 12275/K EN 362/B	  	30	8	-	95
778NNN6PNKK	•	EN 12275/K EN 362/B	  	30	8	-	95
778RPP3P1KK	•	EN 12275/K EN 362/B	  	30	8	-	95

#			Color 	 kN	 kN	 kN	 g
<b>Alu alloy straight gate</b>							
751000100KK	-		 	6	-	-	30
751NN0400KK	-		 	6	-	-	30
751ON0400KK	-		 	6	-	-	30
751VN0400KK	-		 	6	-	-	30
751GN0400KK	-		 	6	-	-	30
751BD0400KK	-		 	6	-	-	30
751RN0400KK	-		 	6	-	-	30
<b>Alu alloy screw sleeve</b>							
751NNN6CNKK	-		  	6	-	-	32

## H.M.S. KEYLOCK

- Aluminum connector available with screw, auto block or twist lock sleeves.
- The classic wide pear shape makes it suitable for belaying with a Münter hitch. It can be used with all anchoring and belaying systems.
- Connettore in alluminio disponibile con ghiera a vite, autoblock e twistlock.
- La classica forma a base larga HMS a pera lo rende adatto per assicurazioni con nodo barcaiole o mezzo barcaiole. Possibilità di utilizzo con tutti i sistemi di ancoraggio e assicurazione, sia in sosta che collegati all'imbraco.

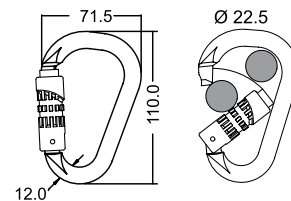
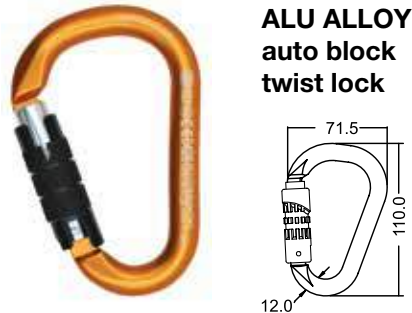
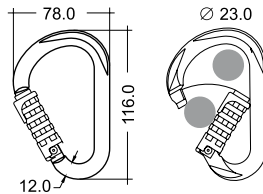
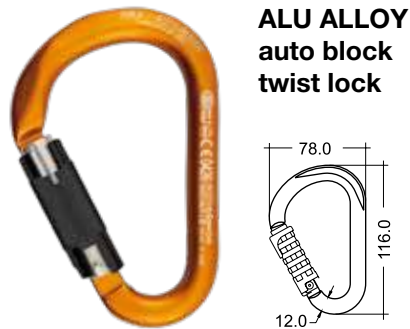
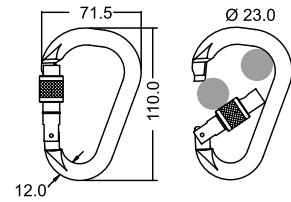
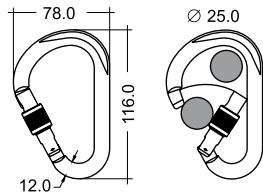

#		CE	Color				
				KN	KN	KN	g
<b>Alu alloy screw sleeve</b>							
786ON06AOKK	•	EN 12275 EN 362/B		22	8	6	88
7860001A1KK	•	EN 12275 EN 362/B		22	8	6	88
786DBD6ADKK	•	EN 12275 EN 362/B		22	8	6	88
786RNP4A1KK	•	EN 12275 EN 362/B		22	8	6	88
<b>Alu alloy auto block</b>							
786OPN7VNKK	•	EN 12275 EN 362/B		22	8	-	95
7860001V1KK	•	EN 12275 EN 362/B		22	8	-	95
786RPP3V1KK	•	EN 12275 EN 362/B		22	8	-	95
786DPB5PBKK	•	EN 12275 EN 362/B		22	8	-	95
<b>Alu alloy twist lock</b>							
786OPN7PNKK	•	EN 12275 EN 362/B		22	8	-	95
7860001P1KK	•	EN 12275 EN 362/B		22	8	-	95
786DPB5VBKK	•	EN 12275 EN 362/B		22	8	-	95

#		CE	Color				
				KN	KN	KN	g
<b>Alu alloy screw sleeve</b>							
957ON06AOKK	•	EN 12275 EN 362/B		23	10	6	80
9570001A1KK	•	EN 12275 EN 362/B		23	10	6	80
957NNN6ANKK	•	EN 12275 EN 362/B		23	10	6	80
957RFP3A1KK	•	EN 12275 EN 362/B		23	10	6	80
957BDB6ABKK	•	EN 12275 EN 362/B		23	10	6	80
<b>Alu alloy auto block</b>							
957OPN7VNKK	•	EN 12275 EN 362/B		23	8	-	91
957RPP3V1KK	•	EN 12275 EN 362/B		23	8	-	91
957BPD5VDKK	•	EN 12275 EN 362/B		23	8	-	91
<b>Alu alloy twist lock</b>							
957OPN7PNKK	•	EN 12275 EN 362/B		23	8	-	89
9570001P1KK	•	EN 12275 EN 362/B		23	8	-	89
957RPP3P1KK	•	EN 12275 EN 362/B		23	8	-	89
957BPD5PDKK	•	EN 12275 EN 362/B		23	8	-	89

## QUEEDY

- Queedy is an aluminum connector for use in scaffolding and work protection systems. Double gate and wide gate opening.
- Connettore in alluminio Kong Queedy per ponteggio/impalcature e sicurezza in ambiente di lavoro. Sblocco a doppia leva e grande apertura.



**ALU ALLOY**  
double gate

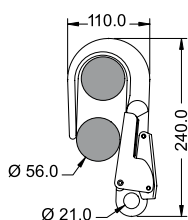

## TANGO KEYLOCK

- Hot forged aluminum carabiner with double gate.
- Ideal for positioning lanyards.
- Connettore in alluminio forgiato a caldo con doppia leva di sicurezza.
- Ideale per realizzare longe di posizionamento.



**ALU ALLOY**  
double gate

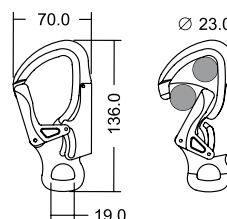

## DOUBLE GATE

- Carbon steel double gate connector for use in work protection systems.
- Connettore in acciaio al carbonio, ideale per uso in ambiente di lavoro, industria, edilizia; utile per costruire sistemi di protezione/arresto caduta / posizionamento.



**CARBON STEEL**  
double gate

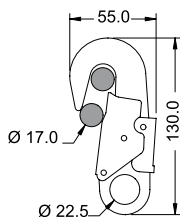

## BBQ

- Stainless steel wide opening clamp, made of high quality stainless steel to be used for anchoring on scaffolding or tubular structures.
- Available in three sizes, with internal gap of 75, 100 and 140 mm.
- Pinza in acciaio inox di alta qualità da utilizzare per ancorarsi su ponteggi o strutture con tubolari di grandi dimensioni.
- Disponibile in tre misure, con passaggio interno da 75, 100 e 140 mm.



**STAINLESS STEEL**

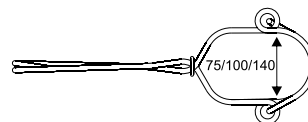

#	UAA	CE	Material	Color	KN	KN	KN	g
<b>Queedy</b>								
71624P1X2KK		EN 362/A	alu alloy	□□	24	-	-	460
71635N3X2KK		EN 362/A	alu alloy	■■	24	-	-	950
<b>Double gate</b>								
416130ZX1KK		EN 362/B	carbon steel	□□	22	-	-	238

#	UAA	CE	Material	Color	KN	KN	KN	g
<b>Tango</b>								
71500NNX2KK		EN 362/T - NFPA-T EN 12275/K	alu alloy	■■	33	12	15	135
71500BPX2KK		EN 362/T - NFPA-T EN 12275/K	alu alloy	■□	33	12	15	135
71500RPX2KK		EN 362/T - NFPA-T EN 12275/K	alu alloy	■□	33	12	15	135
<b>BBQ</b>								
516075000KK		EN 362/B	stainless steel	□	30	-	-	250
516100000KK		EN 362/B	stainless steel	□	30	-	-	280
516140000KK		EN 362/B	stainless steel	□	30	-	-	330

## FROG

- The Kong Frog is a revolutionary directional connector that closes automatically when it touches the anchor point.
- Updated version with improved opening up to 12,7mm.
- Also suitable for metal cables.
- Frog è un connettore rivoluzionario che si chiude automaticamente entrando in contatto con l'ancoraggio.
- Versione aggiornata con apertura aumentata a 12,7mm.
- Adatto anche per utilizzo su cavi metallici.



Watch the video  
Guarda il video

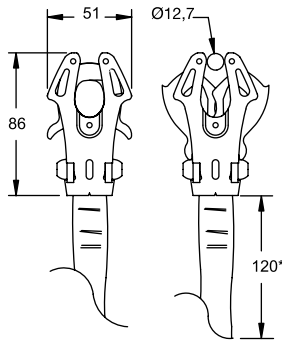

## SOLEYMIEUX

- The stainless steel Soleymieux connector clamps directly onto the Fix Soleymieux bolt.
- The SOLEYMIEUX system is an excellent alternative to traditional bolts and pitons because it reduces the aesthetic impact of the anchor point. A very useful solution, especially when working on historic buildings.
- Using a removable plate eliminates the risk that unauthorized persons could use the anchor point.
- Rinvio in acciaio inox che permette di moschettonare direttamente lo speciale Fix Soleymieux.
- Il sistema Soleymieux è un'ottima alternativa ai tradizionali chiodi e spit in quanto permette di ridurre l'impatto estetico del punto di ancoraggio, soluzione molto utile in particolare quando si lavora su edifici storici.
- Grazie alla possibilità di rimuovere la piastrina si elimina inoltre il rischio di utilizzo del punto di ancoraggio da parte di persone non autorizzate.



**!** See page 60.  
Vedi pagina 60.

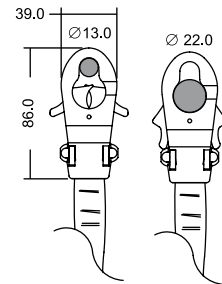

## FROG CABLE

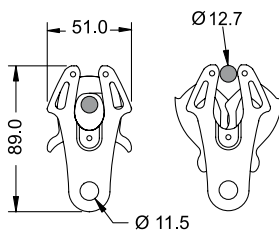

#		CE	Material	Color				
<b>Frog</b>								
704012000KK	•	EN 362/A/T EN 12275/A	alu alloy		22	-	-	74
<b>Frog cable</b>								
7002NN400KK	•	EN 362/A/T EN 12275/A	alu alloy		25	-	-	50

#		CE	Material	Color				
<b>Soleymieux</b>								
761SETSL12K	•	EN 12275/A EN 362/A/T EN 959 - EN 795B	stainless steel		22	-	-	110

## QUICK LINK

- Oval quick link available in stainless steel and carbon steel.
- Maglia rapida ovale disponibile in acciaio inox e acciaio al carbonio.

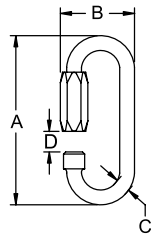

## "D" QUICK LINK

- "D" shape carbon steel quick link.
- Maglia rapida in acciaio al carbonio, forma semirotonda a "D".

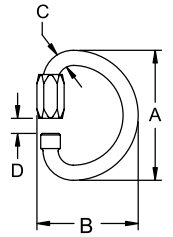

## TRAPEZIUM QUICK LINK

- Trapezoidal stainless steel quick link.
- Maglia rapida trapezoidale in acciaio inox.

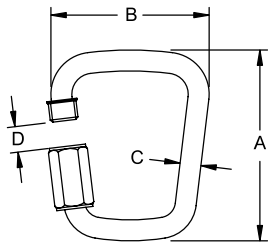

## QUICK LINK ASYMMETRIC

- Asymmetric carbon steel quick link.
- Conceived for use with our Duck rope clamp or other small devices.
- Maglia rapida asimmetrica in acciaio al carbonio.
- Ideata per utilizzo con bloccante Duck o altri dispositivi di regolazione della fune.

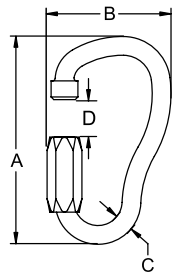

## TRIANGLE QUICK LINK

- Triangle stainless steel quick link.
- Maglia rapida triangolare in acciaio inox.

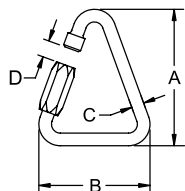

## QUICK LINK LONG

**NEW**

- Oval stainless steel quick link wide opening.
- Maglia rapida ovale in acciaio inox con ampia apertura.

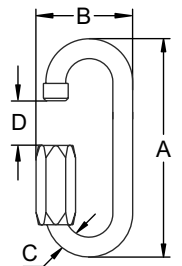

#		CE	Material	Color	Breaking load	Working load				A	B	C	D
					kN	kg	kN	kN	g	mm	mm	mm	mm
<b>Quick link</b>													
400040ZB2XK		-	carbon steel		-	-	-	-	12	41	21	4	6
400050ZB2XK		-	carbon steel		-	-	-	-	20	50	25	5	7
400060ZB2XK		-	carbon steel		-	-	-	-	32	59	29	6	8
400080ZB2XK		-	carbon steel		-	-	-	-	76	73	38	8	10
400100ZB2XK		-	carbon steel		-	-	-	-	135	88	45	10	12
400120ZB2XK		-	carbon steel		-	-	-	-	230	105	52	12	16
6000350D1KK		-	stainless steel		-	230	-	-	9	37	17	3,5	5,5
6000400D1KK		-	stainless steel		-	300	-	-	13	41	21	4	6
6000500D1KK		-	stainless steel		-	450	-	-	22	50	26	5	7
6000600D1KK		-	stainless steel		-	700	-	-	34	58	29	6	8
6000800D1KK	•	EN 12275/Q - EN 362/Q	stainless steel		40	-	25	-	79	74	39	8	10
6001000D1KK	•	EN 12275/Q - EN 362/Q	stainless steel		60	-	30	-	142	89	47	10	12
6001200D1KK		-	stainless steel		-	3000	-	-	222	105	52	12	14
<b>Trapezium quick link</b>													
6380900D1KK		-	stainless steel		-	1000	-	-	129	82	68	9	11
<b>Triangle quick link</b>													
6020800D1KK	•	EN 12275/Q - EN 362/Q	stainless steel		40	-	25	-	89	72	56	8	10
6021000D1KK	•	EN 12275/Q - EN 362/Q	stainless steel		60	-	30	-	155	86	66	10	12
<b>"D" quick link</b>													
409100ZB2KK	•	EN 12275/Q - EN 362/Q	carbon steel		50	-	15	-	152	87	67	11	-
<b>Quick link asymmetric</b>													
403071ZB2KK	•	EN 12275/B - EN 362/Q	carbon steel		25	-	10	-	89	77,5	43,5	7	14
<b>Quick link long</b>													
6170800D1KK	•	EN 12275/Q - EN 362/Q	stainless steel		40	-	25	-	85	88,5	35	8	18

# 9

## What is a descender?

A descender is a device designed to allow a climber to descend a rope at a controlled speed.

## Why choose a Kong descender?

- It is produced in Italy
- It is made of high quality materials and components
- The simple design reduces and simplifies maintenance
- Indy Evo is certified for lowering two people during rescue operations
- Ortis allows you to make emergency evacuations with total management of the descent speed

## Cos'è un discensore?

Si tratta di un dispositivo per la discesa su corda con il quale una persona può scendere a velocità controllata.

## Perché scegliere un discensore Kong?

- È prodotto in Italia
- È realizzato con materiali e componenti di altissima qualità
- La semplicità costruttiva riduce e facilita la manutenzione
- Indy Evo è certificato per la calata di due persone durante le manovre di soccorso
- Ortis permette di effettuare evacuazioni d'emergenza con una gestione totale della velocità di calata







Pirata



Indy Evo Plus



Ortis



Kes 1



Kes 2

# PIRATA

**NEW**

- Descender / Ascender designed for rope access and positioning work.
- The cam system perfectly aligns the rope, limiting twisting during long descents and reducing friction during ascent.
- Simplicity of construction facilitates pre and post use checks and simplifies periodic inspection.
- The stainless steel cams have a long life, even with the most intense use.
- The new articulated lever allows release to be driven by the user's body weight, thus reducing the required force necessary when compared to a traditional brake lever.
- Suitable for skilled and experienced users.
- Discensore/risalitore studiato per agevolare la progressione nel lavoro con accesso e posizionamento mediante funi.
- Il sistema di camme consente il perfetto allineamento della fune limitando l'attorcigliamento nelle lunghe discese e la riduzione degli attriti nelle risalite.
- La semplicità di costruzione facilita il controllo pre e post uso e semplifica l'ispezione periodica.
- Le camme in acciaio inox hanno una durata elevata anche nell'uso più intenso.
- La nuova leva articolata consente l'azionamento sfruttando il peso del corpo e riducendo quindi la forza necessaria rispetto alla tradizionale leva a freno.
- Indicato per utilizzatori formati ed esperti.



Watch the video  
Guarda il video

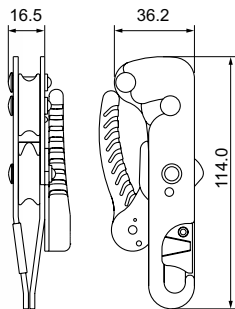

#	CE	Material	Color	g	min.	Ø mm max.
801060400KK	EN 12841/C	alu alloy stainless steel		420	10	12
80106N400KK	EN 12841/C	alu alloy stainless steel		420	10	12



**Hands-free locking**  
Bloccaggio a rilascio



**Descent**  
Discesa



# INDY EVO PLUS

**NEW**

- Evolution of the well-known Indy Evo descender, fitted with a new lever, easier to handle, that allows more fluid and precise working.
- Indy Evo Plus is a manually operated descending device with a double auto locking system that locks both when the lever is released and when it is pressed.
- Indy Evo Plus is also a descender (conforming to EN 12841 type C) for working on rope. It allows descent at a controlled speed, stopping at any time, hands free, on a static rope (EN 1891) or dynamic rope (EN 892). Light weight and compact size, long life guaranteed by the stainless steel cams and low maintenance make it a working tool very much appreciated by the industry.
- Certified for two people, it allows two people to lower at the same time and also allows the user to take in rope slack.
- Evoluzione del noto discensore Indy Evo dotato di una nuova leva più facile da manovrare che permette un funzionamento più fluido e preciso.
- Indy Evo Plus è un dispositivo di discesa a comando manuale dotato di bloccaggio automatico che si attiva sia rilasciando la leva sia tirandola. Indy Evo Plus è inoltre un discensore (conforme alla norma EN 12841 tipo C) per corda da lavoro, che permette una discesa a velocità controllata ed un arresto a mani libere su corde statiche (EN 1891) o dinamiche (EN 892). Le dimensioni e il peso ridotti, la lunga durata garantita dalle camme in acciaio inox e la ridotta manutenzione, ne fanno uno strumento di lavoro molto apprezzato. Certificato per due persone, permette di calare contemporaneamente due persone per manovre di soccorso.
- Permette il recupero della corda per la risalita.



**Certified for two people!**  
Certificato per due persone!







**Allows the user to take in rope slack and ascend!**  
Permette il recupero della corda per la risalita!

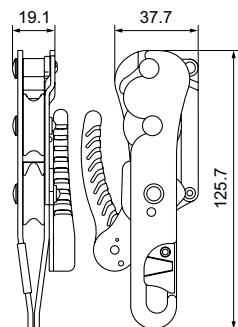

Watch the video  
Guarda il video



#	CE	Material	Color	 g	 min.	 max. Ø mm
801040400KK	EN 341 EN 12841/C NFPA-T	alu alloy stainless steel		480	10	12
80104N400KK	EN 341 EN 12841/C NFPA-T	alu alloy stainless steel		480	10	12

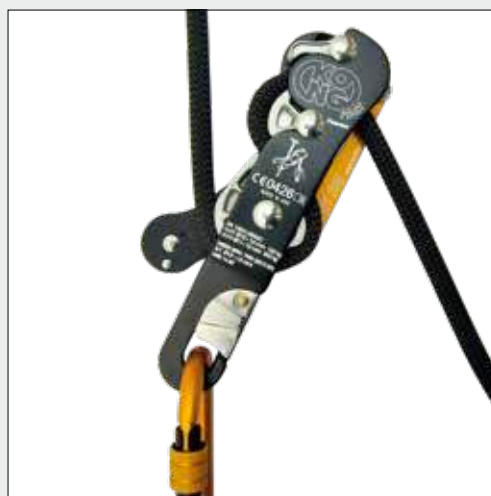

**Hands-free locking**  
Bloccaggio a rilascio



**Descent**  
Discesa

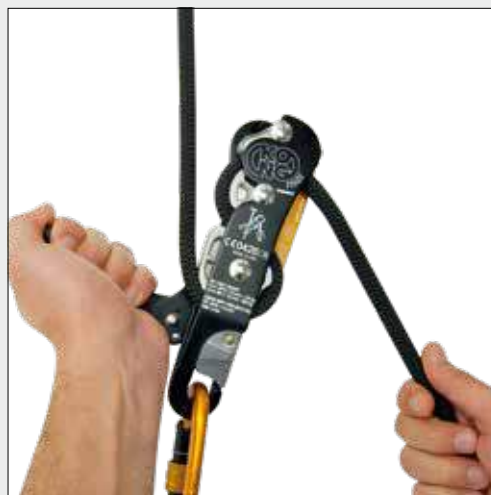

**Locking by pulling**  
Bloccaggio a freno

## KES Kong Evacuation System

- Devices that allow one or more operators an evacuation descent of up to 300 meters from workstations at height (cranes, wind turbines, rigging frames, power lines...).
- The devices are equipped with a 9 mm type A rope and two connectors at the ends.
- The innovative magnetic brake system provides automatic descent speed modulation according to the applied load. The braking system does not wear the mechanical parts nor the rope.
- The slotted rope on both ends allows faster evacuation of more operators in sequence.
- **KES 1:** individual evacuation system from a workstation at height. Load capacity: one person.
- **KES 2:** evacuation system for one or more operators. The steering wheel allows short lifting operations and/or operator evacuation. Load capacity: two people.
- Dispositivi che permettono l'evacuazione di uno o più operatori con una discesa anche fino a 300 metri da luoghi di lavoro in quota (gru, pale eoliche, strutture in carpenteria metallica, elettrodotti...).
- I dispositivi sono dotati di corda con diametro 9 mm di tipo A e di due connettori alle estremità.
- L'innovativo sistema a freni magnetici permette di modulare in automatico la velocità di discesa in base al carico applicato. Il sistema frenante non usura né le parti meccaniche né la corda.
- La corda asolata su entrambi i capi permette l'evacuazione di più operatori in maniera sequenziale.
- **KES 1:** sistema di evacuazione individuale da luoghi di lavoro in quota. Capacità di carico: una persona.
- **KES 2:** sistema di evacuazione di uno o più operatori. Il volante permette un breve sollevamento e l'eventuale svincolo dell'operatore. Capacità di carico per due persone.

#	CE	Color	↔	<>	Speed	👤
			m*	kg	m/sec	kg
<b>KES 1</b>						
228010300KK	EN 341	■ □ ■	30	≤ 150	~ 0.8	4.1
228010500KK	EN 341	■ □ ■	50	≤ 150	~ 0.8	5.3
228010800KK	EN 341	■ □ ■	80	≤ 150	~ 0.8	7.1
<b>KES 2</b>						
228020500KK	EN 341/1A - EN 1496/B	■ ■	50	≤ 225	~ 0.8	7.1
228020800KK	EN 341/1A - EN 1496/B	■ ■	80	≤ 225	~ 0.8	9.0

\* Other lengths on request!  
Altre misure su richiesta!







# ORTIS

- Ortis is a self-locking lowering device, manually run by one operator, used for evacuation from cableways, adventure parks and high work places. Conforming to EN 341 class A standard, a person can be lowered by an operator on a textile rope at a controlled speed (between 0.5 and 2 m/s).
- Fitted with a highly resistant aluminum wheel and pigtail lever to manage the descent speed.
- Important: this device has been designed to be used with an 11mm Ø static rope conforming to EN 1891. It may also be used with other 10 to 13 mm Ø static or dynamic ropes but results could differ from EN 341 class A standard requirements.
- Ortis è un dispositivo di discesa a comando manuale studiato per l'evacuazione di impianti a fune, parchi avventura, ecc...
- È conforme alla norma EN 341 classe A, con il quale una persona può essere calata da un operatore, su una corda tessile a velocità controllata (compresa tra 0.5 e 2 m/s).
- Dotato di tamburo in alluminio altamente resistente e leva a coda di porco per gestire la velocità di calata.
- Importante: Questo dispositivo è stato progettato per essere utilizzato con corda statica 11 mm conforme alla norma EN 1891. In emergenza possono essere utilizzate anche altre corde statiche o dinamiche di diametro compreso tra 10 e 13 mm, in tal caso le prestazioni possono differire da quelle previste dalla norma.

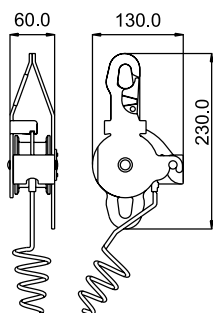

 **Special for evacuation!**  
Speciale per evacuazione!



#		CE	Material	Color	 g	 Ø mm	min.	max.
822000400KK	•	EN 341/2A	alu alloy stainless steel		1200	11	11	

# 10

## What is a rope clamp?

A rope clamp is a mechanical device used for ascending rope by sliding only in one direction, and locking in the opposite direction.

## Why choose a Kong rope clamp?

- It is produced in Italy
- We use only the highest quality materials and components
- Our stainless steel cams receive special thermal and chemical treatments that make them very resistant to wear
- The Futura System was the first example of miniaturization in the rope clamp field and is the only one that works along the axis of the rope, greatly increasing efficiency

## Cos'è un bloccante?

Si tratta di un dispositivo meccanico utilizzato per la risalita su corda in quanto scorre solo in una direzione e si blocca nella direzione opposta.

## Perché scegliere un bloccante Kong?

- È prodotto in Italia
- È realizzato con materiali e componenti di altissima qualità
- Le camme in acciaio ricevono particolari trattamenti termici e chimici che le rendono molto resistenti all'usura
- Il Futura System è stato il primo esempio di miniaturizzazione nel campo dei bloccanti e l'unico che lavora in asse sulla corda aumentando notevolmente l'efficienza



Trender



Lift



Cam-Clean



Futura System

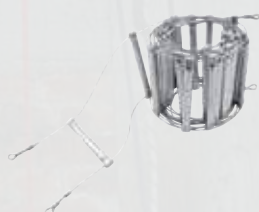

Speleo Stair



Sling Ascender



Help

## TRENDER

- Double ascender conceived specifically for arboriculture. Fitted with a safety system that prevents accidental rope escape and intrusion of branches into the toothed cam. It works on twin ropes from 8 to 13 mm.
- Maniglia doppia per risalita corda, concepita per l'arborismo, dotata di blocco di sicurezza che evita la fuoruscita accidentale della corda e di sistema antintrusione dei rami nella camma dentata. Funziona su corda doppia da 8 a 13mm.



**Safety block prevents accidental opening.**

Blocco di sicurezza per apertura accidentale.



**Intrusion detection system to keep branches clear of the cams.**

Sistema antintrusione dei rami nelle camme.

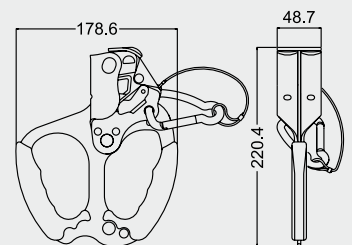
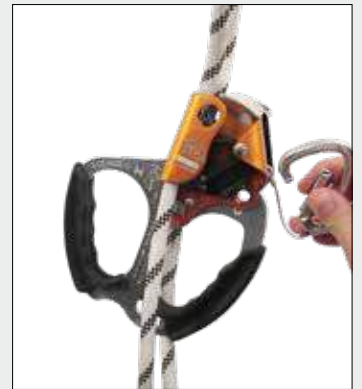

#		CE	Material	Color	g	Ø mm	min.	max.
874030400KK	•	EN 567 EN 12841/B	alu alloy stainless steel		550		8	13



## LIFT







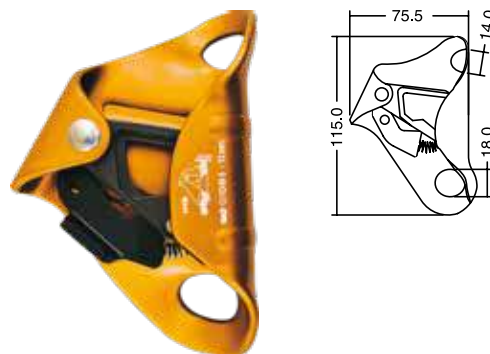

- Rope clamp for rope access, available in left and right versions. All the components are part of the latest generation of Kong rope clamps. Excellent locking ability, particularly on muddy and icy ropes, thanks to the holes in the cam and side plate. The new material and a special chemical and thermal process give the cam a much higher surface hardness in addition to the black color. The result is great wear-resistance and a reduction of the fragility that usually penalizes steels quenched at low temperatures. New opening lever which is ergonomic, easy to handle and protected from shocks and the risk of accidental opening.
- Bloccante mobile per risalita, disponibile in versione destro e sinistro. Utilizza tutta la componentistica di ultima generazione dei bloccanti Kong. Ottima la capacità di bloccare su corde particolarmente infangate grazie alle asole di svuotamento presenti non solo sulla camma ma anche sulla guancia. Il nuovo materiale ed uno speciale procedimento termico e chimico conferiscono alla camma dentata, oltre al colore nero, una durezza superficiale molto superiore. Il risultato è una grande resistenza all'usura ed una riduzione della fragilità che solitamente penalizza gli acciai da tempra alle basse temperature. Nuovo il clicchetto d'apertura, ergonomico, facile da manovrare e molto protetto dagli urti e dal rischio di aperture accidentali.









## CAM-CLEAN

- Chest rope clamp specifically conceived for work at height, rescue, climbing, caving and canyoning.
- All the components are part of the latest generation of Kong rope clamps. Excellent locking ability, particularly on muddy and icy ropes, thanks to the holes in the cam and side plate. The new material and a special chemical and thermal process give the cam a much higher surface hardness in addition to the black color. The result is great wear resistance and a reduction of the fragility that usually penalizes steels quenched at low temperatures. New opening lever which is ergonomic, easy to handle and protected from shocks and the risk of accidental opening.
- Bloccante ventrale di dimensioni ridotte, studiato per la speleologia e per tutte le applicazioni di derivazione speleologica quali soccorso, soccorso in forra, lavori in altezza, canyoning.
- Utilizza tutta la componentistica di ultima generazione dei bloccanti Kong. Ottima la capacità di bloccare su corde particolarmente infangate grazie alle asole di svuotamento presenti sulla camma. Il nuovo materiale ed uno speciale procedimento termico e chimico conferiscono alla camma dentata, oltre al colore nero, una durezza superficiale molto superiore. Il risultato è una grande resistenza all'usura ed una riduzione della fragilità che solitamente penalizza gli acciai da tempra alle basse temperature. Nuovo il clicchetto d'apertura, ergonomico, facile da manovrare e molto protetto dagli urti e dal rischio di aperture accidentali.



#		CE	Material	Color	 g	 min.	 max.
896O04D00KK (right)	•	EN 567 EN 12841/B NFPA 1983:12 T	alu alloy		225	8	13
896R04D00KK (right)	•	EN 567 EN 12841/B NFPA 1983:12 T	alu alloy		225	8	13
896NN4D00KK (right)	•	EN 567 EN 12841/B NFPA 1983:12 T	alu alloy		225	8	13
896NN4S00KK (left)	•	EN 567 EN 12841/B NFPA 1983:12 T	alu alloy		225	8	13

#		CE	Material	Color	 g	 min.	 max.
82400O400KK	•	EN 567 EN 12841/B NFPA 1983:12 T	alu alloy		220	8	13
82400R400KK	•	EN 567 EN 12841/B NFPA 1983:12 T	alu alloy		220	8	13
82400N400KK	•	EN 567 EN 12841/B NFPA 1983:12 T	alu alloy		220	8	13

## FUTURA SYSTEM

- A revolution in the rope clamp world for its extremely tiny dimensions and ergonomic shapes.
- It's the natural marriage between three devices and the best system for ascending a rope. The "ROPE WALKING SYSTEM" is like climbing a ladder.
- After testing the system, users confirm excellent performance and a 30% efficiency gain during ascent.
- Una rivoluzione nel campo dei bloccanti, dimensioni ridotte ed ergonomia sorprendente.
- È il logico connubio di tre attrezzi migliorativi che permette di procedere con un'estrema facilità nella tecnica "alternata", come se si fosse su una scala a pioli!
- Test condotti da speleologi confermano un guadagno minimo del 30% dell'efficacia di risalita.

## FUTURA HAND

- Its small size allows the user to comfortably hold the device close to the rope, in the same way you would grab a rope but much more comfortably. It comes with two different sized handles for ergonomic customization. Available in right and left versions.
- La presa anteriore rispetto alla corda, dona maneggevolezza e sicurezza. Fornita con due impugnature intercambiabili, di differenti misure. Disponibile nella versione per mano destra e sinistra.

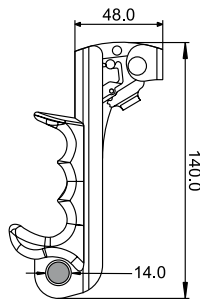

## FUTURA BODY

- Chest ascender, incredibly reduced size and weight, only 80g!
- Bloccante ventrale di dimensioni e peso incredibilmente ridotti, solo 80g!

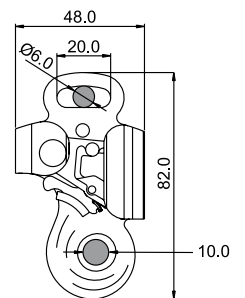

## FUTURA FOOT

- Foot ascender that improves and completes the performance of the Futura Hand ascender and Futura Body chest ascender.
- Available in right and left versions, equipped with anti-torsion stirrup.
- Fitted with a hole for inserting a carabiner that locks the cam, avoiding accidental release of the rope.
- Bloccante supplementare da piede dotato di staffa anti-torsione. Disponibile in versione destra e sinistra.
- Foro per l'inserimento di un connettore per il blocco della camma che evita la fuoriuscita accidentale della corda.

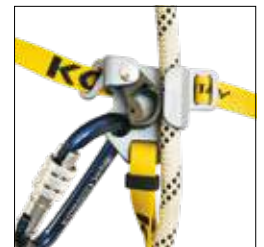
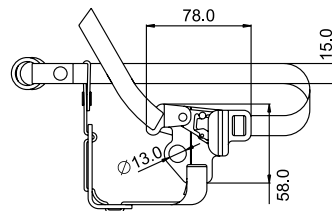

#	UAA	CE	Material	Color	g	Ø mm min. max.
<b>FUTURA HAND</b>						
87600FY4SKK (left)	•	EN 567 EN 12841/B NFPA L	alu alloy	■ ■	125	8 12,7
87600NY4DKK (right)	•	EN 567 EN 12841/B NFPA L	alu alloy	■ ■	125	8 12,7
<b>FUTURA BODY</b>						
82401N400KK	•	EN 567 EN 12841/B	alu alloy	■	80	8 12
<b>FUTURA FOOT</b>						
87609F04DKK (right)	-	-	alu alloy	■	130	8 12
87609N04SKK (left)	-	-	alu alloy	■	130	8 12

## SLING ASCENDER

- Adjustable stirrup (from 90 to 120 cm) made of strong polyamide sling.
- Used with a rope clamp ascender, it helps with rope progression.
- Staffa / Pedale regolabile (da 90 a 120 cm) realizzata in resistente fettuccia di poliammide.
- Utilizzata in abbinamento ad una maniglia di risalita agevola la progressione su corda.

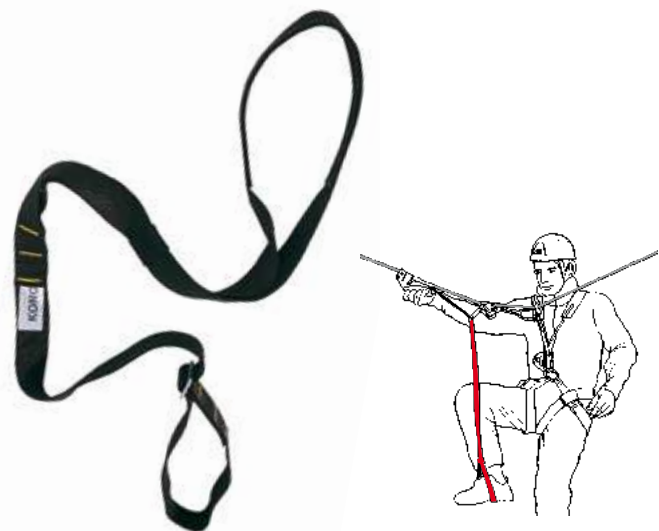

## SPELEO STAIR

- Ladder fitted with two supporting galvanized steel cables and aluminum steps. Dimensions 20.5x16x210 mm.
- Tensile strength: 8 kN
- Available in 3 sizes: 5, 10 and 20 m, other sizes available on request.
- Black steps are available on request.
- Scaletta speleo costituita da 2 cavi portanti in acciaio zincato e scalini in alluminio della misura di 20.5x16x210 mm.
- Carico a rottura: 8 KN.
- Disponibile in 3 misure: 5, 10 e 20 m, altre misure disponibili a richiesta.
- Su richiesta è disponibile la versione con pioli neri.



#	Material	Color	 g
<b>SLING ASCENDER</b>			
834120300KK	polyamide	■	90
<b>SPELEO STAIR</b>			
970050000KK	alu alloy - zinc plated steel	□	900
970100000KK	alu alloy - zinc plated steel	□	1600
970200000KK	alu alloy - zinc plated steel	□	3100

## HELP

- Multi-purpose adjustable stirrup, super compact and lightweight, contained in a handy bag which can be clipped to the harness.
- Made with 3 mm Kevlar cord and equipped with a length-adjustment buckle and stiff pedal made of ultra-durable Nylon.
- Staffa multiuso regolabile, compatta e leggera, contenuta in un pratico sacchetto agganciabile all'imbrago.
- Realizzata con cordino in Kevlar da 3 mm e dotata di pedale e fibbia di regolazione in Nylon ultra-resistente.





## BASEL

**NEW**

- Textile stirrup composed of four steps, designed to help during progression and rope and to facilitate technical passages in work at height.
- Upper and lower attachment points reinforced with protective sheath.
- Reinforcement on every single step that keeps the buttonhole open and facilitates the insertion of the foot.
- Staffa tessile composta da quattro scalini, ideata come ausilio alla progressione e per facilitare passaggi tecnici nel lavoro in quota.
- Punti di attacco superiore e inferiore rinforzati con guaina protettiva.
- Rinforzo su ogni singolo gradino che mantiene aperta l'asola e facilita l'inserimento del piede.



#	Material	Color	 cm	 g
<b>HELP</b>				
834001000KK	kevlar nylon	■	-	110
<b>BASEL</b>				
834010000KK	polyamide	■ ■	1300	245

# 11

## What is a pulley?

It is one or more wheels assembled in a block, or in a case, which can be used in various configurations to handle loads in lifting or lowering.

## Why choose a pulley Kong?

- It is produced in Italy
- It is made of high quality materials and components
- The wide range covers various needs, from mechanical advantage hoists, to the lowering of people and material, to rescue operations and evacuation maneuvers
- Most models are equipped with high efficiency ball bearings

## Cos'è una carrucola?

Si tratta di una o più pulegge montate in un blocco, o in un involucro, che possono essere usate in varie configurazioni per gestire carichi in sollevamento o calata.

## Perché scegliere una carrucola Kong?

- È prodotta in Italia
- È realizzata con materiali e componenti di altissima qualità
- L'ampia gamma Kong permette di coprire le più svariate esigenze, dalla realizzazione di paranchi, alla calata con corda rinviata di persone e carichi, alle manovre di soccorso ed evacuazione
- Quasi tutti i modelli sono dotati di cuscinetti a sfera ad alta efficienza



Futura Mini Block



Twin Block Roll



Twin



Twin Wire



Reflex



Extra Roll



Turbo Roll



Heavy Duty Roll



Swing Alu



Albi



Rolley

## FUTURA MINI BLOCK

- Low friction pulley fitted with a locking device that can be engaged and disengaged through the special pawl. Compact and lightweight, conceived for rescue and mountaineering. Properly used in recovery, it becomes fundamental for the preparation of simple or double hoists in rescue and self-rescue. Mini block belongs to the ultra compact "Futura" family of clamps which can be used for ascending ropes and in case of emergency.
- Carrucola a basso attrito con bloccante inseribile e desinseribile tramite clicchetto, compatta e leggera concepita per alpinismo e soccorso. E' adatta nel recupero di materiali in parete e diventa fondamentale nell'allestimento di paranchi semplici o doppi da soccorso od autosoccorso. Miniblock fa parte della famiglia di bloccanti ultracompati 'Futura' di cui conserva la geometria ed alcuni particolari. Può essere utilizzato anche in caso di emergenza come bloccante per la risalita.



**Only 165 g!**  
Solo 165 g!

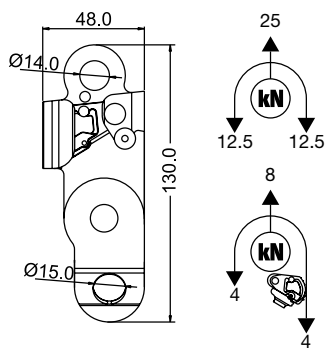
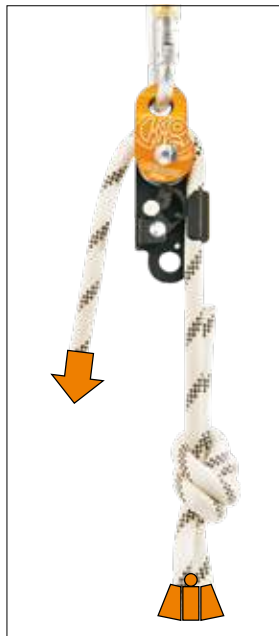

## BLOCK ROLL

- The Block Roll is a single sheave aluminum pulley with ball bearings and auto-block. It works with ropes up to 12mm.
- Carrucola in alluminio con puleggia singola e auto-bloccante. Per corde di diametro max 12mm.

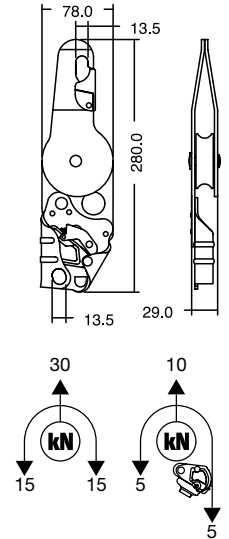

## TWIN BLOCK ROLL

- The Block Roll is a double sheave aluminum pulley with aluminum side plates, ball bearings and auto-block. It works with ropes up to 12mm.
- Carrucola in alluminio con puleggia doppia e auto-bloccante. Per corde di diametro max 12mm.

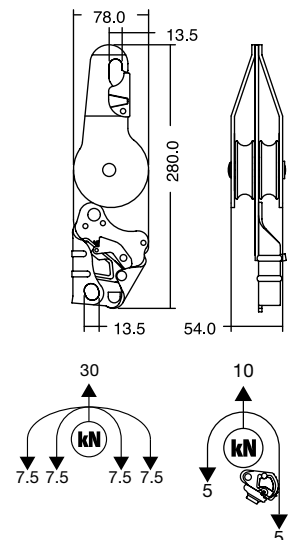

#		CE	Color	Body material	Wheel material	Efficiency %	g	kN			Ø mm max.
<b>FUTURA MINI BLOCK</b>											
81802NO00KK	•	EN 12841 - EN 12278 - EN 567		alu alloy	alu alloy	-	165	25	•		12
<b>BLOCK ROLL</b>											
81800NO00KK	•	EN 12841 - EN 12278 - EN 567		alu alloy	alu alloy	-	550	30	•		13
<b>TWIN BLOCK ROLL</b>											
81801NO00KK	•	EN 12841 - EN 12278 - EN 567		alu alloy	alu alloy	-	740	30	•		13

## TWIN

- Aluminum pulley with double wheel, mobile side plates and high efficiency (96%) ball bearing.
- Equipped with two attachment points for use in complex lifting systems.
- Carrucola in alluminio con doppia puleggia a flange mobili e cuscinetti a sfera ad alta efficienza (96%).
- Dotata di due punti di attacco per l'utilizzo nei sistemi di sollevamento complessi.

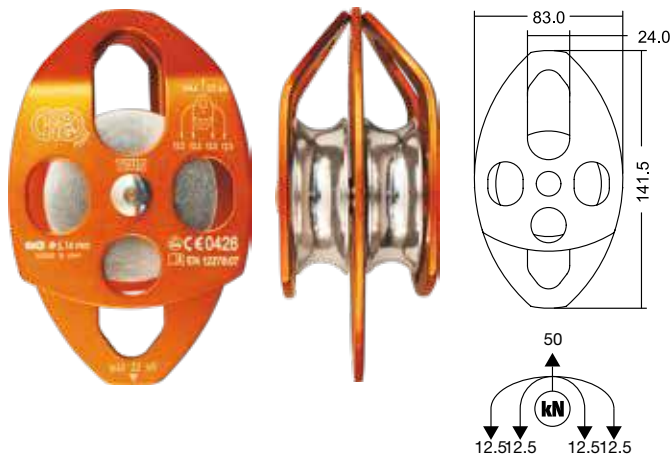

## MINI TWIN

- Compact aluminum pulley with double wheel, mobile side plates and high efficiency (91%) ball bearing.
- Equipped with two attachment points for use in complex lifting systems.
- Carrucola compatta in alluminio con doppia puleggia a flange mobili e cuscinetti a sfera ad alta efficienza (91%).
- Dotata di due punti di attacco per l'utilizzo nei sistemi di sollevamento complessi.



## TWIN WIRE

- Light aluminum alloy pulley with double wheel, mobile side plates and high efficiency (96%) ball bearing.
- Equipped with two attachment points for use in complex lifting systems.
- For ropes up to 16 mm diameter.
- Thanks to the wire gates on both side plates, Twin Wire allows the rope to be inserted without opening the connector.
- Conforms to CE EN 12278.
- Carrucola in lega leggera d'alluminio con doppia puleggia a flange mobili e cuscinetti a sfera ad alta efficienza (96%).
- Dotata di due punti di attacco per l'utilizzo nei sistemi di sollevamento complessi.
- Per corde di diametro max 16 mm.
- Grazie alle leve a filo presenti su entrambe le flange, Twin Wire permette l'inserimento delle corde senza aprire il connettore di carico.
- Certificata CE EN 12278

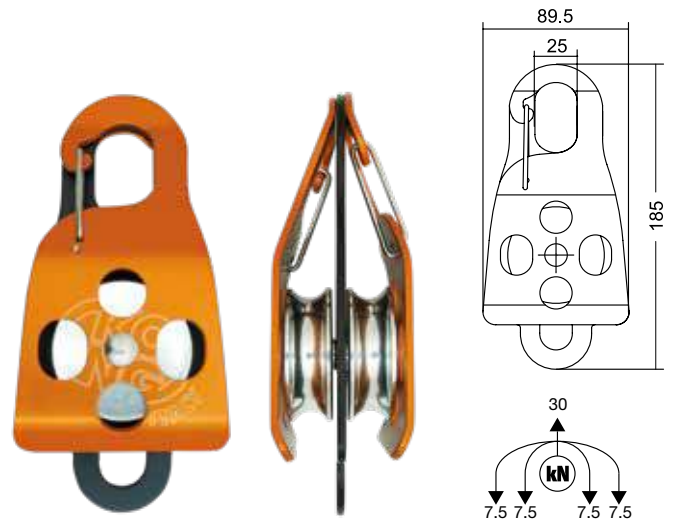

#	UIAA	CE	Color	Body material	Wheel material	Efficiency %	g	kN	Ball bearing	Bush	Ø mm max.
<b>TWIN</b>											
82700OP00KK	•	EN 12278	■	alu alloy	alu alloy	96	490	50	•		16
<b>MINI TWIN</b>											
82701OP00KK	•	EN 12278	■	alu alloy	alu alloy	91	108	30	•		11
<b>TWIN WIRE</b>											
82702OP00KK		EN 12278	■	alu alloy	alu alloy	96	575	30	•		16

## REFLEX

- Aluminum pulley with single wheel, mobile side plates and high efficiency (96%) ball bearing.
- Equipped with two attachment points for use in complex lifting systems.
- Carrucola in alluminio con puleggia singola a flange mobili e cuscinetti a sfera ad alta efficienza (96%).
- Dotata di due punti di attacco per l'utilizzo nei sistemi di sollevamento complessi.

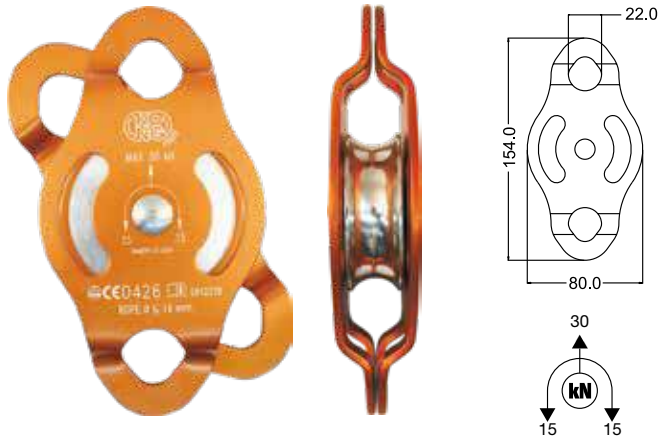

## EXTRA ROLL

- Aluminum pulley with single wheel, mobile side plates and high efficiency (96%) ball bearing.
- Equipped with two attachment points for use in complex lifting systems.
- Carrucola in alluminio con puleggia singola a flange mobili e cuscinetti a sfera ad alta efficienza (96%).



#		CE	Color	Body material	Wheel material	Efficiency %	g	kN	Ball bearing	Bush	Ø mm max.
<b>REFLEX</b>											
82900OP00KK	•	EN 12278		alu alloy	alu alloy	96	270	30	•		16
<b>EXTRA ROLL</b>											
82000OP00KK	•	EN 12278		alu alloy	alu alloy	96	260	30	•		16
82001PN00KK	•	EN 12278		alu alloy	nylon	96	260	30	•		16



## TURBO ROLL

- Compact and lightweight pulley with fixed side plates, aluminum body and ball bearing to ensure optimum efficiency.
- Available in three versions, with nylon, aluminum and galvanized steel wheel.
- For ropes up to 11 mm diameter.
- Carrucola con corpo in alluminio e puleggia singola in nylon a flange fisse e cuscinetti a sfera. Per corde di diametro max 11 mm.

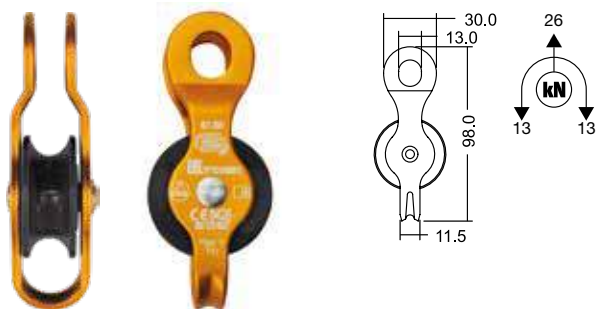

## SWING ALU

- The Swing Roll is a single sheave pulley with aluminum swinging side plates and nylon wheel. Taper bush lock pulley. It works with ropes up to 11 mm.
- Carrucola con corpo in alluminio e puleggia singola in nylon a flange mobili e cuscinetto radente (bronzina). Per corde di diametro max 11 mm.



Available also in carbon steel # 992 and Stainless steel # 994.  
Disponibile anche in acciaio # 992 e acciaio inox # 994.

## HEAVY DUTY ROLL

- The Heavy Duty Roll is a double sheave pulley with aluminum side plates, ball bearings and nylon wheels. It works with ropes up to 20mm.
- Carrucola con corpo in alluminio e puleggia singola in plastica. Per corde di diametro max 20 mm.

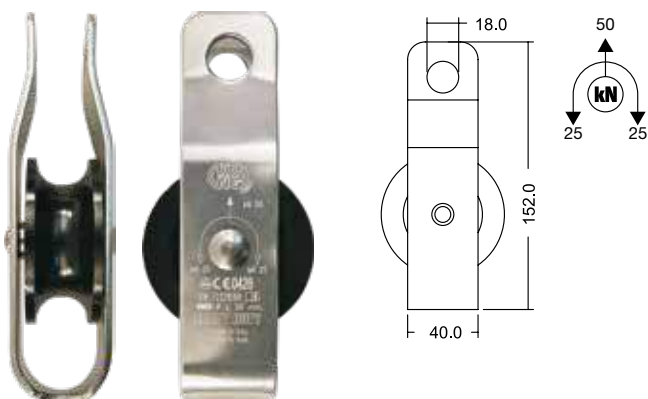

#		CE	Color	Body material	Wheel material	Efficiency %	g	kN	Ball bearing	Bush	Ø mm max.
<b>TURBO ROLL</b>											
82100N00KK	•	EN 12278		alu alloy	nylon	93	70	26	•		11
82102PP00KK	•	EN 12278		alu alloy	alu alloy	93	77	26	•		11
82103RP00KK	•	EN 12278		alu alloy	steel	93	80	26	•		11
<b>HEAVY DUTY ROLL</b>											
81900PR00KK	•	EN 12278		alu alloy	nylon	-	320	50	•		20
<b>SWING ALU</b>											
993N00400KK	•	EN 12278		alu alloy	nylon	87	120	30		•	11

## ALBY

- Alby is a single sheave pulley with aluminum swinging side plates and wheel. Taper bush lock pulley. It works with ropes up to 26mm. Conceived for treeclimbing.
- Carrucola per abbattimento usata per arborismo, con corpo e puleggia singola in alluminio e cuscinetti radenti (bronzina). Per corde di diametro max 26mm.

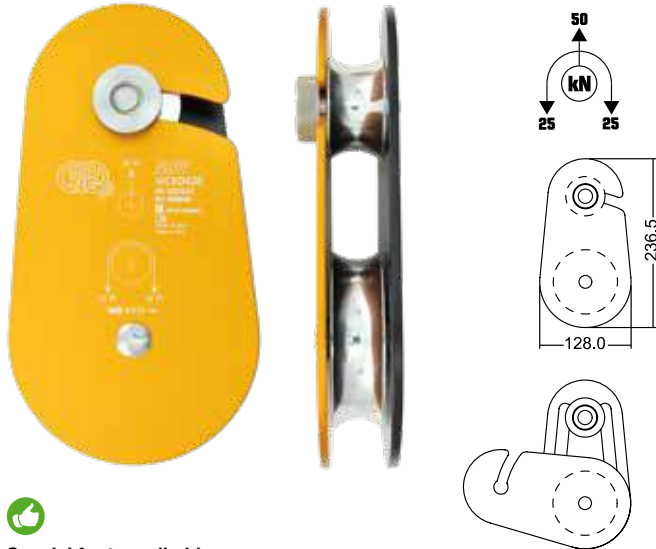

**Special for tree climbing.**  
Speciale per treeclimbing.

## ROLLEY

- Aluminum pulley for evacuation from the cableways with single pulley nylon and sliding bearing (bushing).
- Equipped with locking lever for maximum security once positioned on the cable.
- Available on request special wheels for different cable diameters.
- Carrucola in alluminio per evacuazione da teleferica con puleggia singola in nylon e cuscinetto radente (bronzina).
- Dotata di leva di chiusura che garantisce la massima sicurezza una volta posizionata sul cavo.
- Disponibili su richiesta pulegge per altri diametri di cavo.



**Special for evacuation.**  
Speciale per evacuazione.

## DOUBLE ROLLEY

- Double wheel version of the Rolley pulley, it offers improved stability.
- Versione a due pulegge della carrucola Rolley che garantisce una maggiore stabilità.

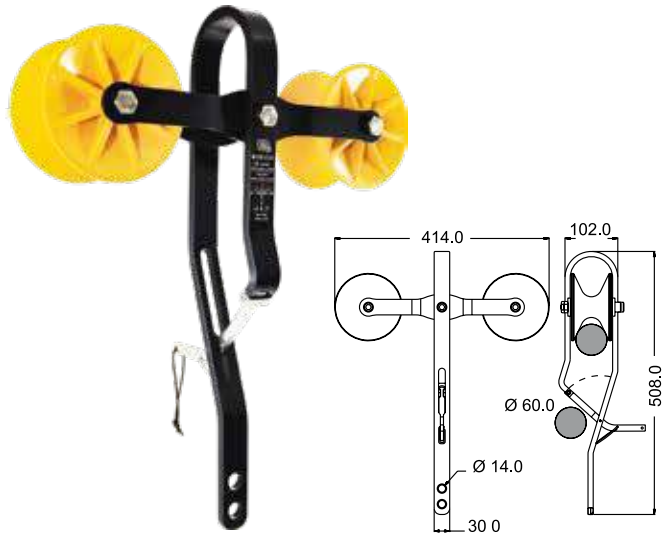

#		CE	Color	Body material	Wheel material	Efficiency %	g	kN			Ø mm max.
<b>ALBY</b>											
83900N00KK	•	EN 12278 EN 795/B		alu alloy	alu alloy	93	1150	50	•	•	26
<b>ROLLEY</b>											
83301NP00KK	•	EN 1909 - EN 12278 EN 795/B		alu alloy	nylon	-	1360	30	•	•	60
<b>DOUBLE ROLLEY</b>											
83302NP00KK	•	EN 1909 - EN 12278 EN 795/B		alu alloy	nylon	-	1500	25	•	•	60

# ROPES & ACCESSORIES

## CORDE E ACCESSORI

# 12



Aramid Core Rope



Static Rope



Rope Id



K-Blade



Rollers

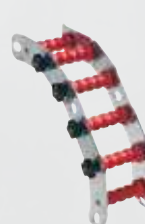

Tergeste



Prothoc



Throwing Bag  
Throwing Line

### What is a cord / textile rope?

It is a linear device composed of a core surrounded by a sheath. Semi static ropes with low elongation are used for professional work.

Kong is the exclusive distributor of Tendon ropes for Italy. For an overview of the full range, please visit [www.mytendon.com](http://www.mytendon.com)

### Cos'è una corda / fune tessile?

È un dispositivo lineare composto da un'anima avvolta da una guaina. Per utilizzi professionali vengono utilizzate corde semi statiche a basso coefficiente di allungamento.

Kong è distributore esclusivo per l'Italia delle corde Tendon, per una visione della gamma completa consultare il sito [www.mytendon.com](http://www.mytendon.com)

## STATIC ROPE

- Static ropes, different sizes. Choose your static rope by following the scheme here beside.
- Corda statica di varie misure. Scegli la tua corda statica seguendo lo schema qui a fianco.

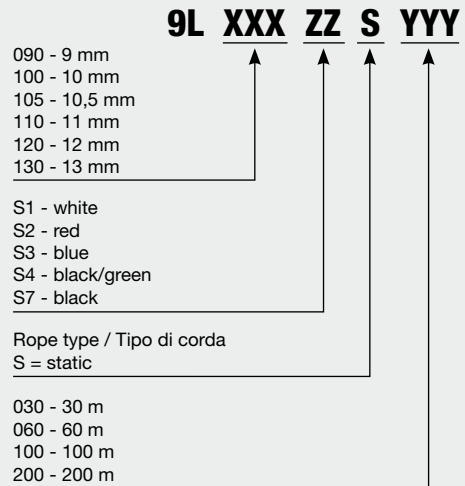

## FORCE

**NEW**

- A special rope which makes use of a technology of combination of materials and the rope construction itself. A rope for use in extremely severe conditions (for instance rescuers, firemen, policemen and other special forces) due to its increased resistance to cutting.
- Corda speciale che utilizza un'innovativa tecnologia di combinazione di materiali, da utilizzare in condizioni estremamente severe (lavoro in ambienti ostili, soccorso, vigili del fuoco, polizia e altre forze speciali) grazie alla maggiore resistenza al taglio.



## SECURE

**NEW**

- A rope for any application where the sheath and the core may suffer damage. When using this rope you will significantly increase your safety margins, in cases where mechanical damage to the rope due to sharp edges or falling objects. Thanks to the unique sandwich-type construction of braided layers and the use of specially developed staple fibers, the rope is able to hold the suspended person or load even in the event of considerable sheath or core damage.
- Corda consigliata per le situazioni in cui la guaina e il nucleo possono subire danni. Utilizzando questa fune si aumentano notevolmente i margini di sicurezza, nei casi in cui si verificano danni meccanici alla corda a causa di spigoli vivi o oggetti in caduta. Grazie alla particolare struttura a sandwich di strati intrecciati e all'utilizzo di fibre di seta particolarmente sviluppate, la corda è in grado di mantenere la persona o il carico sospesi anche in caso di notevoli guasti o danneggiamenti.







#	CE	Ø mm	↔ m	Color	Material	▲ g/m	Number of falls	sheath slippage mm	Elongation %	◆ kN
<b>FORCE</b>										
9L100F1S060	EN 1891	10	60	■	PA/steel	68	5	5	/	24
9L100F1S100	EN 1891	10	100	■	PA/steel	68	5	5	/	24
9L100F1S200	EN 1891	10	200	■	PA/steel	68	5	5	/	24
9L110F1S060	EN 1891	11	60	■	PA/steel	82	5	5	/	26
9L110F1S100	EN 1891	11	100	■	PA/steel	82	5	5	/	26
9L110F1S200	EN 1891	11	200	■	PA/steel	82	5	5	/	26
<b>SECURE</b>										
9L105E1S060	EN 1891/A	10.5	60	■ ■	PA	75	17	/	4.6	28
9L105E1S100	EN 1891/A	10.5	100	■ ■	PA	75	17	/	4.6	28
9L105E1S200	EN 1891/A	10.5	200	■ ■	PA	75	17	/	4.6	28
9L110E3S060	EN 1891/A	11	60	■ ■	PA	84.6	20	/	4.5	35
9L110E3S100	EN 1891/A	11	100	■ ■	PA	84.6	20	/	4.5	35
9L110E3S200	EN 1891/A	11	200	■ ■	PA	84.6	20	/	4.5	35

## ARAMIDIC CORE ROPE

- Kevlar rope 6mm with polyester sheath and aramidic core, 50 m coil.
- Cordino in kevlar da 6mm con anima in aramide e calza in poliestere, bobina da 50 m.



#	 	Material	Ø mm	 g/m	Min. strenght daN	 m	Color
9K0600N0050	• EN 564	aramid/pa	6	22.9	1700	50	

## ROPE ID # 9V0000058KK

**NEW**

- Shrinkable sheath that makes it easy to tag and identify cut rope pieces with a unique serial code (alphanumeric and barcode format CODE 39).
- Guaina termoretraibile che permette con facilità di identificare tramite codice seriale univoco (alfanumerico e codice a barre formato CODE 39) gli spezzoni di corda tagliati.



Watch the video  
Guarda il video





## K-BLADE

- Professional knife ideal for work at height and rescue situations.
- Easily attached to the harness via the large carabiner hole.
- The high quality blade can easily cut slack ropes and cords.
- Fitted with a locking button that prevents the accidental opening of the blade.
- Body made of anodized aluminum alloy with a stainless steel blade.
- Coltello professionale ideale per le situazioni di lavoro in quota e soccorso.
- Facilmente moschettonabile all'imbrago grazie all'ampio foro.
- Lama di alta qualità in grado di tagliare facilmente corde e cordini laschi.
- Pulsante di blocco che evita l'apertura accidentale della lama.
- Corpo realizzato in alluminio anodizzato e lama in acciaio inox.



Watch the video  
Guarda il video

#	Color	Body material	Blade material	 g
954030000KK	 	alu alloy	stainless steel	145



## ROLLERS

- The Rollers module is a compact and lightweight rope protection system made of aluminum alloy. The 3 articulated pieces provide a perfect coverage over any kind of edge. The double nylon rollers allow independent routing of 2 ropes, even in opposite directions.
- Rulliera in lega leggera di alluminio per scorrimento corde in soccorso ed industria. La sua modularità (3 pezzi snodati) lo rende polivalente ed adattabile ad ogni tipo di terreno. I doppi rulli permettono lo scorrimento indipendente di due corde, anche in direzioni opposte.

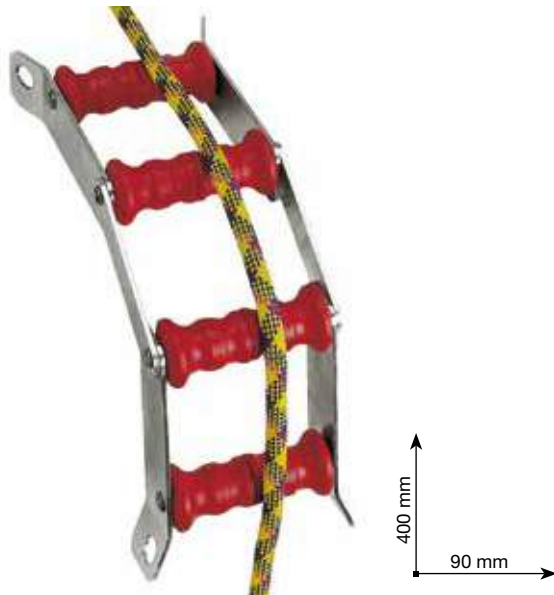

## TERGESTE

- Rope rollers for use in work, rescue, mountaineering and caving.
- New foldable roller-track with 6 double nylon rollers assembled in 5 segments, fitted with blocking devices. Double rollers allow the simultaneous sliding of two ropes in opposite directions. The four blocking bolts allow the correct positioning over edges, for the best slide of the ropes.
- Rulliera in lega leggera di alluminio (alu alloy + nylon) per scorrimento corde, per soccorso, industria, alpinismo, speleologia.
- Polivalente ed adattabile ad ogni tipo di terreno, modulare a 5 pezzi snodati; doppi rulli che permettono lo scorrimento indipendente di due corde, anche in direzioni opposte.



#	Material	Color	g
84000000KK	alu alloy / nylon		870

#	Material	Color	g
84010000KK	alu alloy / nylon		1650

## PROTHOC

**NEW**

- Very light tube made of strong Cordura® used as a protection of ropes against sharp edges.
- Compared to the classic PVC protection, it has a significantly higher resistance and a lower weight.
- The Velcro® closure allows the positioning around the rope in any point.
- Fitted with a plastic ring to fix it avoiding slippage.
- Protezione per corda realizzato in Cordura®.
- Rispetto al classico PVC ha una resistenza sensibilmente maggiore ed un peso ridotto.
- Viene utilizzato in corrispondenza di spigoli dove l'abrasione rischia di logorare la corda.
- Può essere utilizzato in ogni punto della stessa grazie alla sua chiusura con Velcro®.
- L'anello all'estremità permette di attaccarlo ad un punto fisso per mantenerlo in posizione.



#	Material	Color	↔ cm	👤 g
84601N400KK	cordura®	■	70	95

## THROWING BAG THROWING LINE

- Accessories for rope throwing.
- 3 mm throwing line reel, 50 m in length. Two versions of throwing bag, 200 g and 350 g.
- Accessori per il lancio della corda.
- Sagolino da 3 mm in bobina da 50 m e peso in due versioni da 200 g e 350 g



#	Material	Color	↔ m	👤 g
<b>THROWING BAG</b>				
224000000KK	-	■	-	350
224010000KK	-	■	-	200
<b>THROWING LINE</b>				
9A030T1S050	-	-	50	325

# 13

## Why choose a Kong bag?

- It is made of high strength PVC
- Wide range of different dimensions suitable for all uses
- Can be customized with your logo and corporate colors
- The Kong work bags are also used for the storage and transport of our pre-packaged kits

## Perché scegliere un sacco Kong?

- Sono realizzati in PVC di qualità ad altissima resistenza
- Ampia gamma di differenti litraggi adatti a tutti gli utilizzi
- Per quantitativi minimi idonei può essere personalizzato con loghi e colori istituzionali del cliente
- I sacchi da lavoro Kong vengono utilizzati come contenitori per lo stoccaggio e il trasporto dei nostri kit preconfezionati







Rope Bag 100



Rope Bag 200



Omni Bag



Tube



Work Bag



Cargo



Tool Bag

## ROPE BAG

- Backpack for carrying ropes and equipment.
- Fitted with padded shoulder straps for comfort and a loop for hanging.
- Angled closure flap ensures easy access to the contents, with a loop for suspension which ensures convenient access to the bag's contents.
- Drawstring closure and rapid clip made of ultra-durable nylon.
- Transparent side pocket for a name tag.
- Interior zippered pocket for storing small tools.
- Made of extremely durable PVC; reinforced on the bottom with slotted holes for breathability and a handle for emptying.
- Available in two versions:  
28 liters capacity, can hold a 100 m rope  
43 liters capacity, can hold a 200 m rope.
- Zaino per trasporto di corde e attrezzatura dotato di comodi spallacci imbottiti e gancio per la sospensione.
- Patella di chiusura a taglio obliquo e asola per la sospensione che garantiscono un accesso confortevole al contenuto del sacco.
- Chiusura con coulisse e clip rapida in nylon ultra-resistente.
- Tasca laterale trasparente per inserire la targhetta identificativa.
- Tasca interna con cerniera per riporre gli attrezzi più piccoli.
- Realizzato in PVC estremamente resistente; fondo rinforzato con fori asolati per la traspirazione e maniglia per lo svuotamento.
- Disponibile in due versioni:  
capacità 28 litri, può contenere una corda da 100 m  
capacità 43 litri, può contenere una corda da 200 m.



#	Material	Color	Capacity l	Weight g
<b>ROPE BAG 100</b>				
982501000KK	PVC	Orange	28	700
<b>ROPE BAG 200</b>				
982502000NK	PVC	Black	43	800

## OMNI BAG

**NEW**

- Bag for carrying ropes and equipment, with concealable, comfortable padded shoulder straps and removable wide lumbar support.
- Haul loops of different lengths for barycentric suspension.
- Inner wide opening for convenient access to the bag's contents.
- Inner roll closure with aluminium buckle and external drawstring closure.
- Side opening equipped with an ultra-resistant size 10 nylon zip with a protective anti-rubbing flap and an automatic button that prevents accidental opening.
- Rear identification label.
- Rear loop for suspension.
- Transparent side pocket to hold an identification tag.
- Internal removable pocket with zipper and textile loops for storing the smallest of tools.
- Made of extremely durable PVC.
- Reinforced bottom with with wear-resistant edge.
- Double seams at the points of greatest stress.
- 50L capacity which is expandable to 60L.
- Sacca per trasporto di corde e attrezzatura dotato di comodi spallacci imbottiti occultabili e ampio fascione lombare rimovibile.
- Anelli per la sospensione baricentrica di lunghezza differenziata.
- Ampia apertura superiore che garantisce un accesso confortevole al contenuto del sacco.
- Chiusura interna a rullo con fibbia in alluminio e chiusura esterna a coulisse.
- Apertura laterale dotata di zip in nylon taglia 10 ultra-resistente con patella protettiva anti-sfregamento e bottone automatico che evita l'apertura accidentale.
- Etichetta identificativa posteriore.
- Anello posteriore per la sospensione.
- Tasca interna amovibile con cerniera e anelli tessili per riporre gli oggetti più piccoli.
- Realizzato in PVC estremamente resistente.
- Fondo rinforzato e dotato di bordo anti-usura.
- Cuciture doppie nei punti di maggiore sollecitazione.
- Capacità 50 l estendibile a 60 l.

## MINI BAG (optional)

**NEW**

- Optional backpack that can be fixed inside the bag OMNIBAG through dedicated attachments.
- Can be used as rope bag or for personal accessories to be stored separately.
- Opening with 270° double slider zip.
- Fixing loops with different colors for the ends of the rope.
- Internal pocket with zip for documents.
- 3 internal textile loops for fixing materials.
- Capacity 8 l.
- Zaino opzionale fissabile all'interno della sacca OMNIBAG tramite gli attacchi dedicati.
- Utilizzabile come porta-corda o per accessori personali da riporre separatamente.
- Apertura a zip doppio cursore a 270°.
- Asole di fissaggio a colori differenziati per i capi della corda.
- Tasca interna porta-documenti con cerniera.
- 3 asole tessili interne per fissaggio materiali.
- Capacità 8 l.

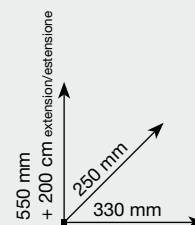
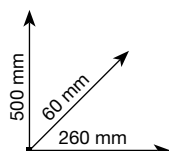

#	Material	Color	Capacity l	g
<b>OMNI BAG</b>				
982524O00KK	PVC	■ ■	60	1300
<b>MINI BAG</b>				
982531O00KK	polyester	■ ■	8	200

## TUBE

**NEW**

- Ultra-light rope bag.
- It can be used alone or as an accessory bag to fit into a bigger backpack.
- It can hold up to 60m of 11mm diameter rope.
- Equipped with handy loops for tying-in the rope ends.
- The upper opening features a rigid cable that holds it in the open position, making it easy to feed rope in and out of the bag.
- Writeable label for quick owner identification.
- Zaino porta corda ultraleggero.
- Può essere utilizzato da solo oppure come sacca accessoria da inserire in uno zaino più grande.
- Può contenere fino a 60m di corda diametro 11mm.
- Dotato di asole metalliche che permettono di tenere i capicorda a portata di mano.
- Apertura superiore dotata di cavetto rigido che la mantiene dilatata agevolando la filatura della corda nella sacca.
- Etichetta scrivibile per una rapida identificazione del proprietario.



## WORK BAG

**NEW**

- Rucksack with comfortable padded adjustable shoulder straps. With longitudinal zip and handles, it can be carried like a duffle bag.
- Zaino dotato di comodi spallacci imbottiti e regolabili. Con cerniera e maniglie longitudinali, può essere trasportato come borsa orizzontale.



#	Material	Color	Capacity l	g
<b>TUBE</b>				
982525000KK	nylon	■	17	155

#	Material	Color	Capacity l	g
<b>WORK BAG</b>				
982528N00KK	PVC	■	50	1800

## CARGO

**NEW**

- Rucksack with comfortable padded adjustable shoulder straps; fitted with an ergonomic back panel, a lateral handle and double suspension haul loops. Inner pocket in the top cover.
- Zaino dotato di comodi spallacci imbottiti e regolabili, schienale ergonomico, maniglia laterale e doppio gancio per sospensione baricentrica. Patella di chiusura con tasca interna.







## TOOL BAG

**NEW**

- Small but strong bag for carrying material and small tools. Fitted with a webbing loop for hanging to a harness.
- Sacco compatto e robusto per contenere materiale e piccoli attrezzi. Dotato di passante in fettuccia per fissaggio alla cintura.



#	Material	Color	Capacity l	 g
<b>CARGO</b>				
982529O00KK	PVC		60	2300

#	Material	Color	Capacity l	 g
<b>TOOL BAG</b>				
982530O00KK	PVC		4	300



*...we don't sell just products,  
we build up a project  
together with our partners...*

*di Brenots*

## YOUR brand on YOUR products

We have a long history of manufacturing products in our own factory in Italy. This has given us a tremendous amount of experience in customizing Your products to fit Your company's image.

### CUSTOMIZATION of CONNECTORS and HARDWARE

You can add your company logo or information -or even your customer's logo or information- to any connector or metal device. You can even choose the color. Through laser marking precision and calibrated anodizing, we can make your product special.

### CUSTOMIZATION of HELMETS

When your customer looks at you they will see your company's logo prominently displayed. What's more visible than a helmet of high quality - made in Italy - with your brand right on it?

A personalized project like this can offer you the best solution for increasing your visibility.

### CUSTOMIZATION of TEXTILES

A harness, a shock absorber or a bag. The limits are only set by your imagination and by how much you want to highlight your brand.



This is possible thanks to local production that allows us, with a minimum quantity of production, to give you what others cannot. Our professional team will support you in the realization of your safety project.

## Il TUO brand sui TUOI prodotti

Attraverso la grande esperienza ed la produzione in Italia, vi possiamo offrire qualcosa di unico: un'esperienza differente sui vostri prodotti e una visibilità diversa per i vostri clienti. Noi rendiamo unici i Tuoi prodotti. Tutti ti riconosceranno!

### PERSONALIZZAZIONE CONNETTORI e HARDWARE

Puoi inserire il tuo logo aziendale o qualsiasi cosa tu preferisca su ogni moschettone o attrezzo metallico. Puoi sceglierne addirittura il colore. Attraverso la laseratura di precisione e la anodizzazione calibrata possiamo rendere speciale il Tuo prodotto.

### PERSONALIZZAZIONE CASCHI

Quando il tuo cliente ti guarderà avrà sempre il tuo logo negli occhi. Cosa c'è di più visibile di un casco di altissima qualità realizzato in Italia e con il tuo brand in evidenza? Attraverso uno studio personalizzato possiamo proporti la soluzione ottimale per aumentare la tua visibilità.

### PERSONALIZZAZIONE PRODOTTI TESSILI

Un imbrago, un assorbitore o un sacco porta materiali. I limiti sono solo dati dalla fantasia e da quanto vuoi far risaltare il tuo marchio.

Tutto questo è possibile grazie alla produzione locale che ci permette, con un quantitativo minimo di produzione, di offrirti ciò che gli altri non possono darti. Il nostro team di professionisti Ti supporterà nella realizzazione del Tuo progetto sicurezza.

#	Description	Ean Code	Page
<b># 2</b>			
201E0900KK	EAW I	8023577057590	49
201E090YKK	EAW I	8023577018324	49
201E150RKK	EAW I	8023577029023	49
201SETE02KK	EAW I SET QUEEDY	8023577024370	49
201SETE05KK	EAW I SET TANGO	8023577024387	49
201SETE09KK	EAW I SET QUEEDY	8023577057606	49
202E0900KK	EAW Y	8023577057613	49
202E090YKK	EAW Y	8023577027180	49
202E150RKK	EAW Y	8023577029030	49
202SETE02KK	EAW Y SET QUEEDY	8023577023649	49
202SETE07KK	EAW Y SET TANGO	8023577024394	49
202SETE12KK	EAW Y SET QUEEDY	8023577057620	49
202SETE13KK	EAW Y SET QUEEDY	8023577057637	49
202SETE15KK	EAW Y SET TANGO	8023577058061	49
20303000KK	EAW BASE		49
203030Y0KK	EAW BASE	8023577008660	49
20602000KK	TEMPORARY LIFELINE	8023577018409	63
20800000KK	MAXI HOIST	8023577028835	69
20800100KK	MINI HOIST	8023577026657	69
20810000KK	MEGA HOIST	8023577055381	69
210A090YKK	TREE FORK	8023577010274	58
210A140NKK	TREE FORK	8023577021690	58
210A230R0KK	TREE FORK	8023577021706	58
22400000KK	THROWING BAG	8023577029375	109
22401000KK	THROWING BAG	8023577029368	109
22501015KK	RETRACTABLE FALL ARRESTER METAL CABLE	8023577029054	50
22501020KK	RETRACTABLE FALL ARRESTER METAL CABLE	8023577025551	50
22502002KK	RETRACTABLE FALL ARRESTER WEBBING 2 M	8023577056791	51
225020025KK	RETRACTABLE FALL ARRESTER WEBBING 2,5 M	8023577029047	50
22502006KK	RETRACTABLE FALL ARRESTER WEBBING 6 M	8023577056777	51
22502010KK	RETRACTABLE FALL ARRESTER METAL CABLE	8023577025544	50
22801030KK	KES 1 - 30 M	8023577053639	90
22801050KK	KES 1 - 50 M	8023577053646	90
22801080KK	KES 1 - 80 M	8023577053653	90
22802050KK	KES 2 - 50 M	8023577053677	90
22802080KK	KES 2 - 80 M	8023577053684	90
271D030R0KK	ARO SLING DYNEEMA®	8023577010595	59
271D060X0KK	ARO SLING DYNEEMA®	8023577007182	59
271D080B0KK	ARO SLING DYNEEMA®	8023577010601	59
271D120R0KK	ARO SLING DYNEEMA®	8023577007199	59
271D150X0KK	ARO SLING DYNEEMA®	8023577014357	59
271D180B0KK	ARO SLING DYNEEMA®	8023577007205	59
271T030N0KK	ARO SLING TUBULAR	8023577014760	58
271T060G0KK	ARO SLING TUBULAR	8023577029535	58
271T080O0KK	ARO SLING TUBULAR	8023577029542	58
271T120R0KK	ARO SLING TUBULAR	8023577007144	58
271T150Y0KK	ARO SLING TUBULAR	8023577007151	58
271T180N0KK	ARO SLING TUBULAR	8023577007168	58
276D040X1KK	Y ARO SPELEO	8023577008509	59
276D055X1KK	Y ARO SPELEO	8023577010649	59
276D060X1KK	Y ARO SPELEO	8023577008516	59
276D075B1KK	Y ARO RESCUE	8023577011073	59
276SETV01KK	DIAPASON	8023577028958	41
277M00100KK	WIRE STEEL ROPE	8023577029061	52
277M00120KK	WIRE STEEL ROPE	8023577057095	52
277M00160KK	WIRE STEEL ROPE	8023577023700	52
277M00200KK	WIRE STEEL ROPE	8023577029078	52
277M00300KK	WIRE STEEL ROPE	8023577037714	52
277M00500KK	WIRE STEEL ROPE	8023577055381	52
277V00200KK	WIRE STEEL ROPE	8023577012261	52
277V00300KK	WIRE STEEL ROPE	8023577029085	52
277V00500KK	WIRE STEEL ROPE	8023577029092	52
278L00060KK	STATIC ROPE LANYARD	8023577029108	53
278L00100KK	STATIC ROPE LANYARD	8023577008677	53
278L00150KK	STATIC ROPE LANYARD	8023577029498	53
278L00200KK	STATIC ROPE LANYARD	8023577014593	53
278L00250KK	STATIC ROPE LANYARD	8023577029115	53
278L00500KK	STATIC ROPE LANYARD	8023577029832	53
278L0100KK	STATIC ROPE LANYARD	8023577026978	53
278L01500KK	STATIC ROPE LANYARD	8023577025605	53
278L0200KK	STATIC ROPE LANYARD	8023577026855	53
278L02500KK	STATIC ROPE LANYARD	8023577025483	53
279I00301KK	DYNAMIC ROPE LANYARD - TRILONGE	8023577052670	53
280A030N0KK	ARO BULL	8023577012223	58
280A060R0KK	ARO BULL	8023577015781	58
280A080Y0KK	ARO BULL	8023577015767	58

#	Description	Ean Code	Page
280A120R0KK	ARO BULL	8023577029511	58
280A150Y0KK	ARO BULL	8023577010694	58
280A180R0KK	ARO BULL	8023577015491	58
281A060R0KK	LANYARD BULL	8023577010588	58
281A080N0KK	LANYARD BULL	8023577011905	58
281A120Y0KK	LANYARD BULL	8023577010571	58
281A150R0KK	LANYARD BULL	8023577029153	58
281A180N0KK	LANYARD BULL	8023577025575	58
289SETU01KK	TRIMMER SET TANGO	8023577031460	54
289SETU02KK	TRIMMER SET TANGO	8023577031507	54
289SETU03KK	TRIMMER SET TANGO	8023577032047	54
289SETU04KK	TRIMMER SET TANGO	8023577031491	54
289SETU21KK	TRIMMER SET QUEEDY	8023577032863	54
289SETU22KK	TRIMMER SET QUEEDY	8023577032061	54
289U00200KK	TRIMMER	8023577032313	54
289U00300KK	TRIMMER	8023577031071	54
289U00400KK	TRIMMER	8023577031088	54
289U00500KK	TRIMMER	8023577031064	54
<b># 4</b>			
400040ZB2XK	QUICK LINK CARBON STEEL	8023577013633	85
400050ZB2XK	QUICK LINK CARBON STEEL	8023577013640	85
400060ZB2XK	QUICK LINK CARBON STEEL	8023577014005	85
400080ZB2XK	QUICK LINK CARBON STEEL	8023577013657	85
400100ZB2XK	QUICK LINK CARBON STEEL	8023577013664	85
400120ZB2XK	QUICK LINK CARBON STEEL	8023577035024	85
403071ZB2KK	QUICK LINK ASYMMETRIC	8023577021812	85
409100ZB2KK	"D" QUICK LINKS	8023577008738	85
411120ZL1KK	X-LARGE CARBON STEEL SCREW SLEEVE	8023577015576	78
411120ZOZKK	X-LARGE CARBON STEEL ANSI AUTO BLOCK	8023577015217	78
411120ZTZKK	X-LARGE CARBON STEEL ANSI TWIST LOCK	8023577013848	78
411120ZYZKK	X-LARGE CARBON STEEL AUTO BLOCK	8023577015255	78
411120ZZZKK	X-LARGE CARBON STEEL TWIST LOCK	8023577013831	78
412110ZL1KK	OVALONE CARBON STEEL SCREW SLEEVE	8023577011622	74
412110ZOZKK	OVALONE CARBON STEEL ANSI AUTO BLOCK	8023577015262	74
412110ZTZKK	OVALONE CARBON STEEL ANSI TWIST LOCK	8023577013855	74
412110ZYZKK	OVALONE CARBON STEEL AUTO BLOCK	8023577015279	74
412110ZZZKK	OVALONE CARBON STEEL TWIST LOCK	8023577027296	74
414110ZOZKK	OVALONE DNA CARBON ANSI AUTO BLOCK	8023577055381	76
414110ZTZKK	OVALONE DNA CARBON ANSI TWIST LOCK	8023577055398	76
414110ZZZKK	OVALONE DNA CARBON AUTO BLOCK	8023577055404	76
414110ZZZKK	OVALONE DNA CARBON TWIST LOCK	8023577055411	76
416130ZX1KK	DOUBLE GATE	8023577024523	83
436120ZC1KK	HARNESS CARBON STEEL SCREW SLEEVE	8023577023526	79
436120ZYZKK	HARNESS CARBON STEEL AUTO BLOCK	8023577013817	79
462100ZC1KK	OVAL CLASSIC CARBON STEEL SCREW SLEEVE	8023577008455	77
465100ZC1KK	OVAL D STEEL SCREW SLEEVE	8023577011561	77
472120ZC1KK	HEAVY DUTY CARBON STEEL SCREW SLEEVE	8023577008745	80
<b># 5</b>			
5111200L3KK	X-LARGE STAINLESS STEEL SCREW SLEEVE	8023577011912	78
5111200Y3KK	X-LARGE STAINLESS STEEL AUTO BLOCK	8023577013015	78
5111200Z3KK	X-LARGE STAINLESS STEEL TWIST LOCK	8023577029191	78
5121100I1KK	OVALONE STAINLESS STEEL ANSI TWIST LOCK	8023577052892	74
5121100K1KK	OVALONE STAINLESS STEEL ANSI AUTO BLOCK	8023577052908	74
5121100L3KK	OVALONE STAINLESS STEEL SCREW SLEEVE	8023577052861	74
5121100Y3KK	OVALONE STAINLESS STEEL AUTO BLOCK	8023577052885	74
5121100Z3KK	OVALONE STAINLESS STEEL TWIST LOCK	8023577052878	74
516075000KK	BBQ	8023577029290	83
516100000KK	BBQ	8023577029603	83
516140000KK	BBQ	8023577012117	83
<b># 6</b>			
6000350D1KK	QUICK LINKS	8023577008752	85
6000400D1KK	QUICK LINKS	8023577008769	85
6000500D1KK	QUICK LINKS	8023577008776	85
6000600D1KK	QUICK LINKS	8023577008783	85
6000800D1KK	QUICK LINKS	8023577008790	85
6001000D1KK	QUICK LINKS	8023577008806	85
6001200D1KK	QUICK LINKS	8023577008813	85
6020800D1KK	TRIANGLE QUICK LINKS	8023577008820	85
6021000D1KK	TRIANGLE QUICK LINKS	8023577008837	85
6170800D1KK	QUICK LINK LONG	8023577055428	85
6380900D1KK	TRAPEZIUM QUICK LINK	8023577014340	85
<b># 7</b>			
7002NN400KK	FROG CABLE	8023577012421	84
701500000KK	WIDE SOLEMIEUX	8023577029146	60
704012000KK	FROG	8023577029443	84
7120001A1KK	OVALONE ALU ALLOY SCREW SLEEVE	8023577011783	75
7120001P1KK	OVALONE ALU ALLOY TWIST LOCK	8023577014968	75



#	Description	Ean Code	Page
712NNN6VNBK	OVALONE ALU ALLOY AUTO BLOCK	8023577029580	75
712ON06AOKK	OVALONE ALU ALLOY SCREW SLEEVE	8023577055428	75
7120PN7PNKK	OVALONE ALU ALLOY TWIST LOCK	8023577054582	75
7120PN7VNBK	OVALONE ALU ALLOY AUTO BLOCK	8023577054599	75
712RNP4A1KK	OVALONE ALU ALLOY SCREW SLEEVE	8023577014036	75
712RPP3P1KK	OVALONE ALU ALLOY TWIST LOCK	8023577028606	75
712RPP3V1KK	OVALONE ALU ALLOY AUTO BLOCK	8023577029573	75
71500BPX2KK	TANGO	8023577018560	83
71500NNX2KK	TANGO	8023577011066	83
71500RPX2KK	TANGO	8023577012377	83
71624P1X2KK	QUEEDY	8023577024769	93
71635N3X2KK	QUEEDY	8023577029283	93
7300001A1KK	OVAL CLASSIC ALU ALLOY SCREW SLEEVE	8023577012063	77
730BPP3A1KK	OVAL CLASSIC ALU ALLOY SCREW SLEEVE	8023577024783	77
730NNN6ANKK	OVAL CLASSIC ALU ALLOY SCREW SLEEVE	8023577014227	77
730ON06AOKK	OVAL CLASSIC ALU ALLOY SCREW SLEEVE	8023577054568	77
730RPP3A1KK	OVAL CLASSIC ALU ALLOY SCREW SLEEVE	8023577024790	77
751000100KK	MINI D ALU ALLOY STRAIGHT GATE	8023577013701	81
751BD0400KK	MINI D ALU ALLOY STRAIGHT GATE	8023577033433	81
751GN0400KK	MINI D ALU ALLOY STRAIGHT GATE	8023577033815	81
751NN0400KK	MINI D ALU ALLOY STRAIGHT GATE	8023577018447	81
751NNN6CNKK	MINI D ALU ALLOY SCREW SLEEVE	8023577026824	81
751ON0400KK	MINI D ALU ALLOY STRAIGHT GATE	8023577056098	81
751RN0400KK	MINI D ALU ALLOY STRAIGHT GATE	8023577018430	81
751VN0400KK	MINI D ALU ALLOY STRAIGHT GATE	8023577055657	81
761SETSL12K	SOLEIMIEUX	8023577029689	84
7780001A1KK	FERRATA ALU ALLOY SCREW SLEEVE	8023577014630	81
7780001P1KK	FERRATA ALU ALLOY TWIST LOCK	8023577015170	81
7780001V1KK	FERRATA ALU ALLOY AUTO BLOCK	8023577029726	81
778NNN6ANKK	FERRATA ALU ALLOY SCREW SLEEVE	8023577029702	81
778NNN6PNKK	FERRATA ALU ALLOY TWIST LOCK	8023577012452	81
778NNN6VNBK	FERRATA ALU ALLOY AUTO BLOCK	8023577052717	81
778RPP3P1KK	FERRATA ALU ALLOY TWIST LOCK	8023577029719	81
778RPP3V1KK	FERRATA ALU ALLOY TWIST LOCK	8023577029733	81
7830001A1KK	ERGO ALU ALLOY SCREW SLEEVE	8023577008097	80
7830001P1KK	ERGO ALU ALLOY TWIST LOCK	8023577015033	80
7830001V1KK	ERGO ALU ALLOY AUTO BLOCK	8023577006802	80
783NCP4A1KK	ERGO ALU ALLOY SCREW SLEEVE	8023577023465	80
783NNN6ANKK	ERGO ALU ALLOY SCREW SLEEVE	8023577024875	80
783NNN6VNBK	HEAVY DUTY ALU ALLOY SCREW SLEEVE	8023577011547	80
7860001A1KK	H.M.S. ALU ALLOY SCREW SLEEVE	8023577008899	82
7860001P1KK	H.M.S. ALU ALLOY TWIST LOCK	8023577014494	82
7860001V1KK	H.M.S. ALU ALLOY AUTO BLOCK	8023577028347	82
786DBD6ADKK	H.M.S. ALU ALLOY SCREW SLEEVE	8023577033440	82
786DPB5PBKK	H.M.S. ALU ALLOY AUTO BLOCK	8023577033457	82
786DPB5VBKK	H.M.S. ALU ALLOY TWIST LOCK	8023577033464	82
786ON06AOKK	H.M.S. ALU ALLOY SCREW SLEEVE	8023577054131	82
786OPN7PNKK	H.M.S. ALU ALLOY TWIST LOCK	8023577054117	82
786OPN7VNBK	H.M.S. ALU ALLOY AUTO BLOCK	8023577054124	82
786RNP4A1KK	H.M.S. ALU ALLOY SCREW SLEEVE	8023577021775	82
786RPP3V1KK	H.M.S. ALU ALLOY AUTO BLOCK	8023577018379	82
<b># 8</b>			
801040400KK	INDY EVO PLUS	8023577055428	89
80104N400KK	INDY EVO PLUS	8023577056845	89
801060400KK	PIRATA	8023577055442	88
80106N400KK	PIRATA	8023577059570	88
802080000KK	TRIMMER DEVICE	8023577055459	53
8020N0400KK	BACK-UP	8023577014999	48
8020N0402KK	BACK-UP	8023577026640	48
8021N0400KK	BACK-UP ANSI	8023577029481	48
8021N0402KK	BACK-UP ANSI	8023577056982	48
8021N0403KK	BACK-UP ANSI	8023577056999	48
8021N0404KK	BACK-UP ANSI	8023577057002	48
802300000KK	BACK-UP MAGNET	8023577055466	48
815010000KK	FIX SOLEYMIEUX	8023577029740	60
815020000KK	FIX SOLEYMIEUX	8023577029757	60
815030000KK	FIX SOLEYMIEUX	8023577030470	60
815040000KK	FIX SOLEYMIEUX	8023577030487	60
817000000KK	ORTLES	8023577008462	68
817030000KK	DRILL ADAPTER	8023577043920	64
817400000KK	GRIZZLY	8023577031361	65
817500000KK	MINI STELVIO 4D	8023577055190	65
81800N000KK	BLOCK ROLL	8023577054650	100
81801N000KK	TWIN BLOCK ROLL	8023577054667	100
81802N000KK	FUTURA MINI BLOCK	8023577015132	100
81900PRO0KK	HEAVY DUTY ROLL	8023577008264	103
82000PO00KK	EXTRA ROLL	8023577008400	102

#	Description	Ean Code	Page
82001PN00KK	EXTRA ROLL	8023577011677	102
82100N000KK	TURBO ROLL	8023577054605	103
82102PP00KK	TURBO ROLL	8023577009292	103
82103RP00KK	TURBO ROLL	8023577009308	103
822000400KK	ORTIS	8023577055466	91
82400N400KK	CAM-CLEAN	8023577009469	95
824000400KK	CAM-CLEAN	8023577030531	95
82400R400KK	CAM-CLEAN	8023577009001	95
82401N400KK	FUTURA SYSTEM - BODY	8023577011202	96
82700PO00KK	TWIN	8023577008394	101
82701PO00KK	MINI TWIN	8023577008387	101
82702PO00KK	TWIN WIRE	8023577029337	101
82900PO00KK	REFLEX	8023577008417	102
83301NP00KK	ROLLEY	8023577054612	104
83302NP00KK	DOUBLE ROLLEY	8023577054629	104
834001000KK	HELP	8023577029313	97
834010000KK	BASEL	8023577059556	97
834120300KK	SLING ASCENDER	8023577007540	97
83900N000KK	ALBY	8023577053820	104
840000000KK	ROLLERS	8023577009032	108
840100000KK	TERGESTE	8023577025025	108
842010000KK	CEVEDALE MONO	8023577014951	64
842020000KK	CEVEDALE BASE	8023577008479	64
84601N400KK	PROTHOC	8023577029351	109
864N15400KK	FULL	8023577030562	62
864010400KK	RALLY	8023577055473	63
864011400KK	RALLY BENT	8023577055473	63
864015400KK	FULL	8023577029627	62
864016400KK	3RIG	8023577055466	62
864017400KK	4RIG	8023577055473	62
873000000KK	PEGASUS	8023577014234	42
874030400KK	TRENDER	8023577008073	94
87600FY4SKK	FUTURA SYSTEM - HAND	8023577006871	96
87600NY4DKK	FUTURA SYSTEM - HAND	8023577011196	96
87609F04DKK	FUTURA SYSTEM - FOOT	8023577006895	96
87609N04SKK	FUTURA SYSTEM - FOOT	8023577006901	96
885020000KK	Y TOOL LEASH	8023577035215	59
885050000KK	TOOL LEASH	8023577051314	59
896NN4D00KK	LIFT RIGHT	8023577009261	95
896NN4S00KK	LIFT LEFT	8023577009070	95
896004D00KK	LIFT RIGHT	8023577053448	95
896R04D00KK	LIFT RIGHT	8023577014456	95
897080000KK	WIDE EYE	8023577009117	61
897100000KK	WIDE EYE	8023577009124	61
897120000KK	WIDE EYE	8023577009131	61
8W0023000KK	SAFETY BELT	8023577025162	41
8W0025000KK	SAFETY BELT	8023577025179	41
8W0053000KK	SIERRA DUO ANSI	8023577053721	40
8W0055000KK	SIERRA DUO ANSI	8023577053738	40
8W0060000KK	HAMMOCK	8023577059051	41
8W0060N00KK	HAMMOCK	8023577060675	41
8W0323000KK	SIERRA DUO	8023577028934	40
8W0325000KK	SIERRA DUO	8023577025186	40
8W0603000KK	SIERRA TRIO	8023577025193	40
8W0605000KK	SIERRA TRIO	8023577028941	40
8W9632000KK	TARGET PRO INDUSTRIAL TURBO		36
8W9633000KK	TARGET PRO INDUSTRIAL TURBO		36
8W9635000KK	TARGET PRO INDUSTRIAL TURBO		36
8W9732000KK	TARGET PRO INDUSTRIAL		36
8W9733000KK	TARGET PRO INDUSTRIAL	8023577055206	36
8W9735000KK	TARGET PRO INDUSTRIAL		36
8W9832001KK	TARGET PRO TURBO	8023577053400	37
8W9833001KK	TARGET PRO TURBO	8023577053387	37
8W9835001KK	TARGET PRO TURBO	8023577053394	37
8W9902001KK	HHO TURBO	8023577058764	38
8W9902101KK	HHO "FLAME RETARDANT"	8023577059648	38
8W9903001KK	HHO TURBO	8023577057224	38
8W9903101KK	HHO "FLAME RETARDANT"	8023577032221	38
8W9905001KK	HHO TURBO	8023577057217	38
8W9905101KK	HHO "FLAME RETARDANT"	8023577032214	38
8W9932000KK	TARGET PRO	8023577027258	37
8W9933000KK	TARGET PRO	8023577027265	37
8W9935000KK	TARGET PRO	8023577027272	37
8W9953000KK	EKO	8023577014920	39
8W9955000KK	EKO	8023577025216	39
8W9963000KK	EKTOR	8023577029450	38
8W9965000KK	EKTOR	8023577029467	38

#	Description	Ean Code	Page
<b># 9</b>			
9110001A1KK	X-LARGE ALU ALLOY SCREW SLEEVE	8023577009186	79
911NNN6ANKK	X-LARGE ALU ALLOY SCREW SLEEVE	8023577009254	79
9110N06A0KK	X-LARGE ALU ALLOY SCREW SLEEVE	8023577054148	79
9110PN7PNKK	X-LARGE ALU ALLOY TWIST LOCK	8023577055473	79
9110PN7VNNKK	X-LARGE ALU ALLOY AUTO BLOCK	8023577054155	79
911RPP3P1KK	X-LARGE ALU ALLOY TWIST LOCK	8023577029177	79
911RPP3V1KK	X-LARGE ALU ALLOY AUTO BLOCK	8023577026701	79
911RXP4A1KK	X-LARGE ALU ALLOY SCREW SLEEVE	8023577024240	79
930028000KK	ANA	8023577055855	61
930046000KK	ANA	8023577021607	61
9480N0400KK	DANCER	8023577006826	61
951010B00KK	KLIK 2 - BLUE	802357703297	33
951010O00KK	KLIK 2 - ORANGE	8023577054032	33
951010R00KK	KLIK 2 - RED	8023577059013	33
951011B00KK	KLIK MICRO - BLUE	8023577032450	33
951011O00KK	KLIK MICRO - ORANGE	8023577054049	33
95201YWF2KK	ALEX GLOVES	8023577025247	45
95201YWF4KK	ALEX GLOVES	8023577025254	45
95201YWF6KK	ALEX GLOVES	8023577012070	45
95201YWF7KK	ALEX GLOVES	8023577012087	45
95201YWF8KK	ALEX GLOVES	8023577012094	45
95201YWF9KK	ALEX GLOVES	8023577026343	45
95202BN02KK	POP GLOVES	8023577007410	45
95202BN03KK	POP GLOVES	8023577007427	45
95202BN04KK	POP GLOVES	8023577007434	45
95202BN05KK	POP GLOVES	8023577007441	45
95202BN06KK	POP GLOVES	8023577025261	45
95202BN09KK	POP GLOVES	8023577007458	45
95203NNN3KK	FULL GLOVES	8023577028965	45
95203NNN4KK	FULL GLOVES	8023577028972	45
95203NNN6KK	FULL GLOVES	8023577028989	45
95203NNN7KK	FULL GLOVES	8023577028996	45
95203NNN8KK	FULL GLOVES	8023577029009	45
95203YWF2KK	FULL GLOVES	8023577025278	45
95203YWF4KK	FULL GLOVES	8023577025285	45
95203YWF6KK	FULL GLOVES	8023577012292	45
95203YWF7KK	FULL GLOVES	8023577012308	45
95203YWF8KK	FULL GLOVES	8023577025292	45
95205N002KK	SKIN GLOVES	8023577026312	44
95205N004KK	SKIN GLOVES	8023577026329	44
95205N006KK	SKIN GLOVES	8023577026336	44
95205N007KK	SKIN GLOVES	8023577026305	44
95207NNN3KK	PRO GLOVES M	8023577055329	44
95207NNN4KK	PRO GLOVES L	8023577055336	44
95207NNN5KK	PRO GLOVES XL	8023577055343	44
95208NNN3KK	PRO AIR GLOVES M	8023577055350	44
95208NNN4KK	PRO AIR GLOVES L	8023577055367	44
95208NNN5KK	PRO AIR GLOVES XL	8023577055374	44
954030000KK	K-BLADE	8023577029887	107
9570001A1KK	H.M.S. NAPIK ALU ALLOY SCREW SLEEVE	8023577012773	82
9570001P1KK	H.M.S. NAPIK ALU ALLOY TWIST LOCK	8023577033303	82
957BDB6ABKK	H.M.S. NAPIK ALU ALLOY SCREW SLEEVE	8023577031156	82
957BPD5PDKK	H.M.S. NAPIK ALU ALLOY TWIST LOCK	8023577034065	82
957BPD5VDKK	H.M.S. NAPIK ALU ALLOY AUTO BLOCK	8023577034072	82
957NNN6ANKK	H.M.S. NAPIK ALU ALLOY SCREW SLEEVE	8023577013923	82
957ON06A0KK	H.M.S. NAPIK ALU ALLOY SCREW SLEEVE	8023577054537	82
9570PN7PNKK	H.M.S. NAPIK ALU ALLOY TWIST LOCK	8023577054544	82
9570PN7VNNKK	H.M.S. NAPIK ALU ALLOY AUTO BLOCK	8023577054551	82
957RFP3A1KK	H.M.S. NAPIK ALU ALLOY SCREW SLEEVE	8023577032306	82
957RFP3P1KK	H.M.S. NAPIK ALU ALLOY TWIST LOCK	8023577018386	82
957RFP3V1KK	H.M.S. NAPIK ALU ALLOY AUTO BLOCK	8023577029276	82
970050000KK	SPELEO STAIR 5 M	8023577009193	97
970100000KK	SPELEO STAIR 10 M	8023577009209	97
970200000KK	SPELEO STAIR 20 M	8023577009223	97
979SET200KK	BAOBAB	8023577029160	68
982501000KK	ROPE BAG 100	8023577025353	112
982502000KK	ROPE BAG 200	8023577029405	112
982524000KK	OMNI BAG	8023577053295	113
982525000KK	TUBE	8023577054636	114
982528000KK	WORK BAG	8023577029399	114
982529000KK	CARGO	8023577029412	115
982530000KK	TOOL BAG	8023577029610	115
982531000KK	MINI BAG	8023577056616	113
982SET040KK	SET PLE 02	8023577048437	21
982SET041KK	SET PLE 03	8023577048444	21
982SET042KK	SET PLE 04	8023577032931	21

#	Description	Ean Code	Page
993N00400KK	SWING ALU	8023577015811	103
997045000KK	NET VISOR	8023577060323	32
997046P00KK	VISORS TRANSPARENT LONG	8023577053110	32
997051N00KK	MOUSE PLATES	8023577015521	29
997056F00KK	VISORS SMOKED	8023577014029	32
997056P00KK	VISORS TRANSPARENT	8023577014012	32
99711AW00KK	AMPERE	8023577060330	31
99718AA02KK	MOUSE WORK	8023577035352	29
99718AN02KK	MOUSE WORK	8023577010281	29
99718AO02KK	MOUSE WORK	8023577023694	29
99718AR02KK	MOUSE WORK	8023577011240	29
99718AW02KK	MOUSE WORK	8023577010304	29
99718AY02KK	MOUSE WORK	8023577010328	29
99718FR02KK	MOUSE HV RED REFLECTIVE	8023577032085	30
99718FW02KK	MOUSE HV WHITE REFLECTIVE	8023577032078	30
99718FY02KK	MOUSE HV YELLOW FLUO REFLECTIVE	8023577023687	30
99718GN02KK	MOUSE WORK	8023577011264	29
99720A000KK	SPIN ANSI	8023577055473	28
99720AW00KK	SPIN ANSI	8023577055480	28
99720AY00KK	SPIN ANSI	8023577055947	28
999130000KK	EARMUFFS	8023577060330	32
999140000KK	EARMUFFS	8023577049403	32
999160000KK	EARMUFFS	8023577049427	32
999170000KK	BLUETOOTH COMMUNICATION SYSTEM	4054596454651	33
999180000KK	EARMUFFS	8023577060132	32
999190000KK	EARMUFFS	8023577060149	32
999200000KK	EARMUFFS	8023577060156	32
999210000KK	EARMUFFS	8023577060163	32
9A030T1S050	THROWING LINE	8023577032467	109
9K060N0050	ARAMIDIC CORE ROPE	8023577029658	107
9L100F1S060	FORCE 10 MM - 60 M	8023577060330	106
9L100F1S100	FORCE 10 MM - 100 M	8023577060347	106
9L100F1S200	FORCE 10 MM - 200 M	8023577055558	106
9L105E1S060	SECURE 10.5 MM - 60 M	8023577055480	106
9L105E1S100	SECURE 10.5 MM - 100 M	8023577055497	106
9L105E1S200	SECURE 10.5 MM - 200 M	8023577055503	106
9L110E3S060	SECURE 11 MM - 60 M	8023577055510	106
9L110E3S100	SECURE 11 MM - 100 M	8023577055527	106
9L110E3S200	SECURE 11 MM - 200 M	8023577055534	106
9L110F1S060	FORCE 11 MM - 60 M		106
9L110F1S100	FORCE 11 MM - 100 M		106
9L110F1S200	FORCE 11 MM - 200 M		106
9V0000058KK	ROPE ID	8023577055541	107

**NOTE**

The contents of this catalogue may not be used or copied not even in part without quoting the source and without written permission from KONG S.P.A. All rights reserved. As specifications, design, production and techniques are in continuous evolution this brochure should not be regarded as an infallible guide. All data, colours of items and technical specifications given may be subject to change and improvement without warning or notice. Our web site www.kong.it is constantly up-dated and/or corrected.

Il contenuto di questo catalogo non può essere usato o riportato parzialmente senza citare la fonte e senza il permesso scritto della KONG S.P.A. Tutti i diritti sono riservati. Poichè le specifiche, la progettazione, la produzione e le tecniche sono in continua evoluzione, tale catalogo non deve essere considerato una guida infallibile. Tutti i dati, i colori degli articoli e le caratteristiche tecniche riportati possono subire modifiche e miglioramenti senza alcun preavviso. Il ns. sito www.kong.it viene costantemente aggiornato e/o corretto.

Follow us

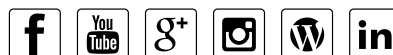



Where we are, reach us  
Dove siamo, raggiungi



**KONG s.p.a.**

Via XXV Aprile, 4 - (zona industriale)

I - 23804 MONTE MARENZO (LC) - ITALY

Tel +39 0341630506 - Fax +39 0341641550 - info@kong.it

**www.kong.it**

"Campione gratuito di modico valore (art. 2 c. 3 DPR 633/72)"

KONG - WORK 2019  
REV. D - EM/IT



8 023577 051697